

LAB MANUAL BOOK

SIMULATION & ANALYSIS LABORATORY

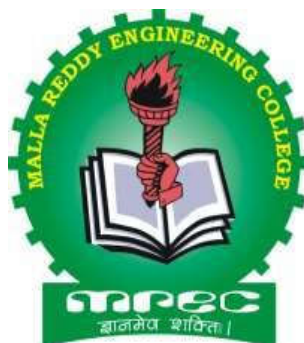

*submitted in partial fulfilment of the requirements for
the award of degree of*

BACHELOR OF TECHNOLOGY in MECHANICAL ENGINEERING



DEPARTMENT OF MECHANICAL ENGINEERING

MALLAREDDY ENGINEERING COLLEGE (AUTONOMOUS)

(An Autonomous Institution approved by UGC and affiliated to JNTUH, Approved by AICTE, Accredited by NAAC with 'A' Grade and NBA & Recipient of World Bank Assistance under TEQIP Phase-IIS.C.1.1)

Maisammaguda, Dhulapally (Post. Via. Kompally), Secunderabad - 500100.

NOVEMBER - 2021

TABLE OF CONTENTS

S.No	Date	Experiment Name	Page No	Staff Signature
Simulation				
1		Introduction to MATLAB		
Analysis				
2		Study of Basics in ANSYS		
Structural Analysis (1D Element)				
3		Static analysis of Cantilever beam with UDL		
4		Static analysis of Simply Supported beam with UDL and Point load		
5		Static analysis on Fixed beam with UDL and UVL		
Structural Analysis (2D Element)				
6		Static analysis on 2D Truss element (1D Link)		
7		Static analysis on a 2D Plate Component		
8		Static analysis on a 2D L – Bracket		
9		Static analysis on a thin cylindrical pipe(Axisymmetric)		
Dynamic analysis				
10		Modal analysis on a simply supported beam		
11		Harmonic Analysis on a Cantilever beam		
12		Transient Analysis on a simple Mechanical Element		
Thermal Analysis				
13		Conductive Heat Transfer analysis on a 3D element (Cube)		
14		Conductive and Convective Heat transfer Analysis on a Furnace wall		
15		Thermal stress Analysis on a Boiler shell		

Ex.No	01	INTRODUCTION TO MATLAB
Date		

Aim:

To Study the capabilities of Mat Lab Software.

Introduction

The MATLAB is a high-performance language for technical computing Integrates computation, visualization, and programming in an easy-to-use environment where problems and solutions are expressed in familiar mathematical notation.

Typical uses include

- Math and computation
- Algorithm development
- Data acquisition
- Modeling, simulation, and prototyping
- Data analysis, exploration, and visualization
- Scientific and engineering graphics
- Application development, including graphical user interface building

MATLAB is an interactive system whose basic data element is an array that does not require dimensioning. It allows you to solve many technical computing problems, especially those with matrix and vector formulations, in a fraction of the time it would take to write a program in a scalar non interactive language such as C or FORTRAN. The name MATLAB stands for matrix laboratory. MATLAB was originally written to provide easy access to matrix software developed by the LINPACK and EISPACK projects.

Today, MATLAB engines incorporate the LAPACK and BLAS libraries, embedding the state of the art in software for matrix computation

SIMULINK INTRODUCTION:

Simulink is a graphical extension to MATLAB for modeling and simulation of systems. In Simulink, systems are drawn on screen as block diagrams. Many elements of block diagrams are available, such as transfer functions, summing junctions, etc., as well as virtual input and output devices such as function generators and oscilloscopes. Simulink is integrated with MATLAB and data can be easily transferred between the programs. In these tutorials, we will apply Simulink to the examples from the MATLAB tutorials to model the systems, build controllers, and simulate the systems. Simulink is supported on Unix, Macintosh, and Windows environments; and is included in the student version of MATLAB for personal computers.

The idea behind these tutorials is that you can view them in one window while running Simulink in another window. System model files can be downloaded from the tutorials and opened in Simulink. You will modify and extend this system while learning to use Simulink for system modeling, control, and simulation. Do not confuse the windows, icons, and menus in the tutorials for your actual Simulink windows. Most images in these tutorials are not live - they simply display what you should see in your own Simulink windows. All Simulink operations should be done in your Simulink windows.

1. Starting Simulink

2. Model Files
3. Basic Elements
4. Running Simulations
5. Building Systems

Starting Simulink

Simulink is started from the MATLAB command prompt by entering the following command:

```
>> Simulink
```

Alternatively, you can hit the Simulink button at the top of the MATLAB window as shown below:

When it starts, Simulink brings up the Simulink Library browser.

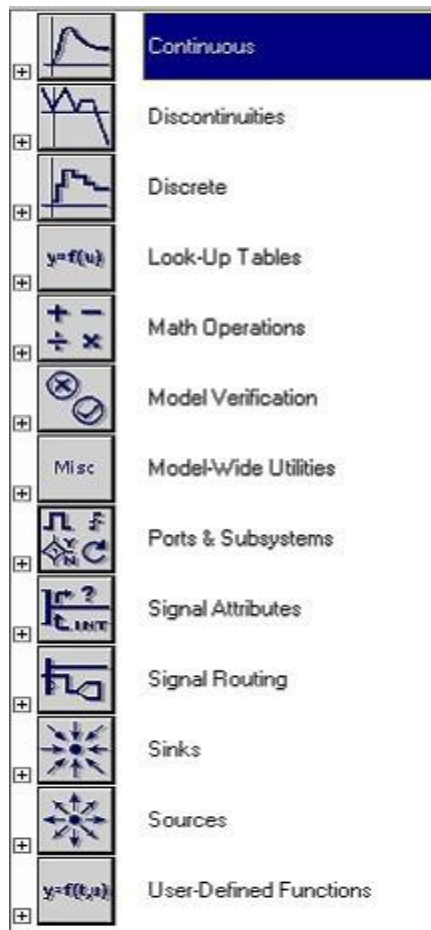

Open the modeling window with New then Model from the File menu on the Simulink Library Browser as shown above.

This will bring up a new untitled modeling window shown below

Model Files

In Simulink, a model is a collection of blocks which, in general, represents a system. In addition to drawing a model into a blank model window, previously saved model files can be loaded either from the File menu or from the MATLAB command prompt.

You can open saved files in Simulink by entering the following command in the MATLAB command window. (Alternatively, you can load a file using the Open option in the File menu in Simulink, or by hitting Ctrl+O in Simulink.) >> Filename

The following is an example model window.

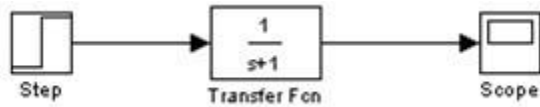

A new model can be created by selecting New from the File menu in any Simulink window (or by hitting Ctrl+N).

Basic Elements

There are two major classes of items in Simulink: blocks and lines. Blocks are used to generate, modify, combine, output, and display signals. Lines are used to transfer signals from one block to another.

Blocks

There are several general classes of blocks:

- Continuous
- Discontinuous
- Discrete
- Look-Up Tables
- Math Operations
- Model Verification
- Model-Wide Utilities
- Ports & Subsystems
- Signal Attributes
- Signal Routing

Sinks: Used to output or display signals

Sources: Used to generate various signals

User-Defined Functions

Discrete: Linear, discrete-time system elements (transfer functions, state-space models, etc.)

Linear: Linear, continuous-time system elements and connections (summing junctions, gains, etc.)

Nonlinear: Nonlinear operators (arbitrary functions, saturation, delay, etc.)

Connections: Multiplex, Demultiplex, System Macros, etc.

Blocks have zero to several input terminals and zero to several output terminals. Unused input terminals are indicated by a small open triangle. Unused output terminals are indicated by a small triangular point. The block shown below has an unused input terminal on the left and an unused output terminal on the right.



Lines

Lines transmit signals in the direction indicated by the arrow. Lines must always transmit signals from the output terminal of one block to the input terminal of another block. One exception to this is a line can tap off of another line, splitting the signal to each of two destination blocks, as shown below.

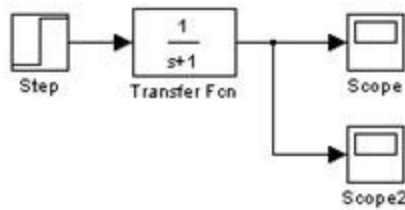

Lines can never inject a signal *into* another line; lines must be combined through the use of a block such as a summing junction.

A signal can be either a scalar signal or a vector signal. For Single-Input, Single-Output systems, scalar signals are generally used. For Multi-Input, Multi-Output systems, vector signals are often used, consisting of two or more scalar signals. The lines used to transmit scalar and vector signals are identical. The type of signal carried by a line is determined by the blocks on either end of the line.

Simple Example



The *simple* model (from the model files section) consists of three blocks: Step, Transfer Fcn, and Scope. The Step is a source block from which a step input signal originates. This signal is transferred through the line in the direction indicated by the arrow to the Transfer Function linear block. The Transfer Function modifies its input signal and outputs a new signal on a line to the Scope. The Scope is a sink block used to display a signal much like an oscilloscope.

There are many more types of blocks available in Simulink, some of which will be discussed later. Right now, we will examine just the three we have used in the simple model.

Running Simulations

To run a simulation, we will work with the following model file: simple2.mdl Download and open this file in Simulink following the previous instructions for this file. You should see the following model window.

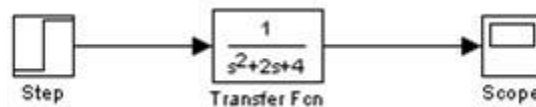

Before running a simulation of this system, first open the scope window by double-clicking on the scope block. Then, to start the simulation, either select Start from the Simulation menu (as shown below) or hit Ctrl-T in the model window.

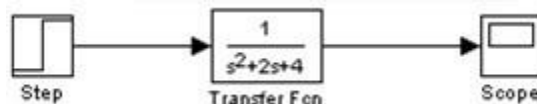

The simulation should run very quickly and the scope window will appear as shown below. If it doesn't, just double click on the block labeled "scope."

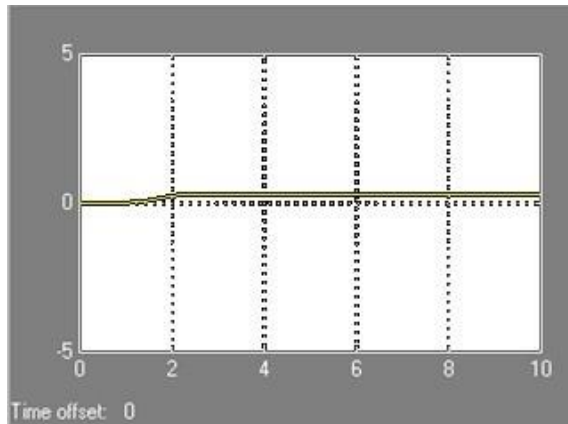

Note that the simulation output (shown in yellow) is at a very low level relative to the axes of the scope. To fix this, hit the autoscale button (binoculars), this will rescale the axes as shown below.

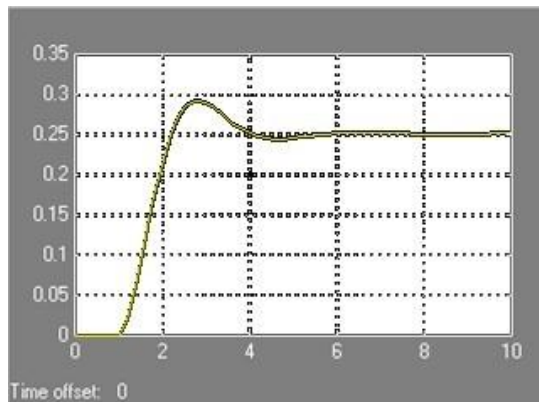

Note that the step response does not begin until $t=1$. This can be changed by double-clicking on the "step" block. Now, we will change the parameters of the system and simulate the system again. Double-click on the "Transfer Fcn" block in the model window and change the denominator to $[1 \ 20 \ 400]$

Re-run the simulation (hit Ctrl-T) and you should see what appears as a flat line in the scope window. Hit the autoscale button, and you should see the following in the scope window.

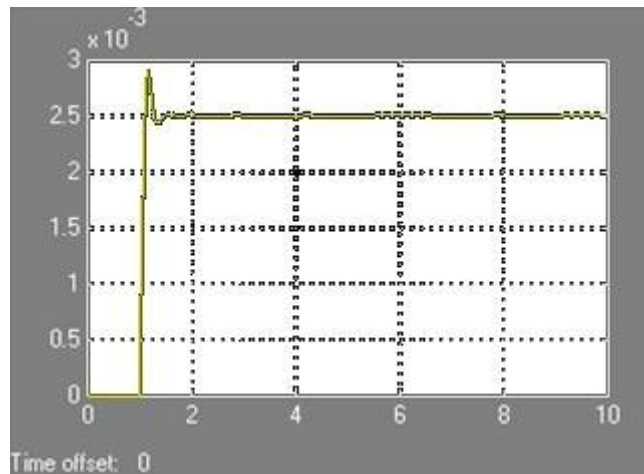

Notice that the autoscale button only changes the vertical axis. Since the new transfer function has a very fast response, it compressed into a very narrow part of the scope window. This is not really a problem with the scope, but with the

simulation itself. Simulink simulated the system for a full ten seconds even though the system had reached steady state shortly after one second.

To correct this, you need to change the parameters of the simulation itself. In the model window, select Parameters from the Simulation menu. You will see the following dialog box.

There are many simulation parameter options; we will only be concerned with the start and stop times, which tell Simulink over what time period to perform the simulation. Change Start time from 0.0 to 0.8 (since the step doesn't occur until $t=1.0$). Change Stop time from 10.0 to 2.0, which should be only shortly after the system settles. Close the dialog box and rerun the simulation.

After hitting the autoscale button, the scope window should provide a much better display of the step response as shown below.

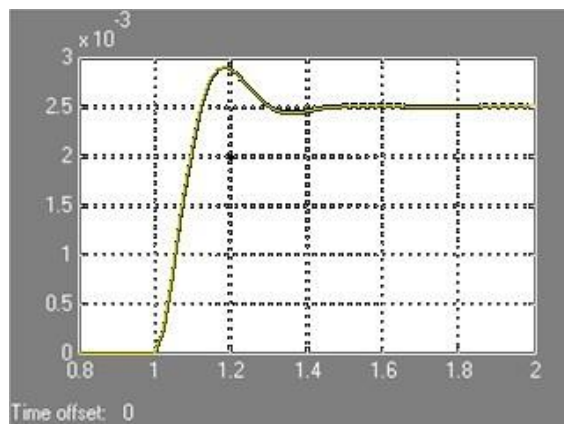

Result

Thus the features of MATLAB are studied.

Ex.No	02	STUDY OF BASICS IN ANSYS
Date		

Aim:

To study about the basic procedure to perform the analysis in ANSYS.

Performing a Typical ANSYS Analysis:

The ANSYS program has many finite element analysis capabilities, ranging from a simple, linear, static analysis to a complex, nonlinear, transient dynamic analysis. The analysis guide manuals in the ANSYS documentation set describe specific procedures for performing analyses for different engineering disciplines. The next few sections of this chapter cover general steps that are common to most analyses.

A typical ANSYS analysis has three distinct steps:

- a. Build the model.
- b. Apply loads and obtain the solution.
- c. Review the results.

1. Defining the Job name:

The job name is a name that identifies the ANSYS job. When you define a job name for an analysis, the job name becomes the first part of the name of all files the analysis creates. (The extension or suffix for these files' names is a file identifier such as .DB.) By using a job name for each analysis, you ensure that no files are overwritten.

2. Defining an Analysis Title:

The TITLE command (Utility Menu> File> Change Title), defines a title for the analysis. ANSYS includes the title on all graphics displays and on the solution output. You can issue the /STITLE command to add subtitles; these will appear in the output, but not in graphics displays.

3. Defining Units:

The ANSYS program does not assume a system of units for your analysis. Except in magnetic field analyses, you can use any system of units so long as you make sure that you use that system for all the data you enter. (Units must be consistent for all input data.)

4. Defining Element Types:

The ANSYS element library contains more than 150 different element types. Each element type has a unique number and a prefix that identifies the element category: BEAM4, PLANE77, SOLID96, etc. The following element categories are available:

Beam, Mesh
Multipoint constraint

COMBINation	PIPE
CONTACT	PLANE
FLUID	PRETS (Pretension)
HF (High Frequency)	SHELL
HYPERelastic	SOLID
INFINite	SOURCe
INTERface	SURFace
LINK	TARGET
MASS	TRANSducer
MATRIX	USER
	VISCOelastic (or viscoplastic)

5. Defining Element Real Constants:

Element real constants are properties that depend on the element type, such as cross-sectional properties of a beam element. For example, real constants for BEAM3, the 2-D beam element, are area (AREA), moment of inertia (IZZ), height (HEIGHT), shear deflection constant (SHEARZ), initial strain (ISTRN), and added mass per unit length (ADDMAS). Not all element types require real constants, and different elements of the same type may have different real constant values.

6. Defining Material Properties:

Most element types require material properties. Depending on the application, material properties can be linear (see Linear Material Properties) or nonlinear (see Nonlinear Material Properties). As with element types and real constants, each set of material properties has a material reference number. The table of material reference numbers versus material property sets is called the material table. Within one analysis, you may have multiple material property sets (to correspond with multiple materials used in the model). ANSYS identifies each set with a unique reference number.

7. Creating the Model Geometry:

Once you have defined material properties, the next step in an analysis is generating a finite element model - nodes and elements - that adequately describes the model geometry. The graphic below shows some sample finite element models.

There are two methods to create the finite element model: solid modeling and direct generation. With solid modeling, you describe the geometric shape of your model, and then instruct the ANSYS program to automatically mesh the geometry with nodes and elements. You can control the size and shape in the elements that the program creates. With direct generation, you "manually" define the location of each node and the connectivity of each element. Several convenience operations, such as copying patterns of existing nodes and elements, symmetry reflection, etc. are available.

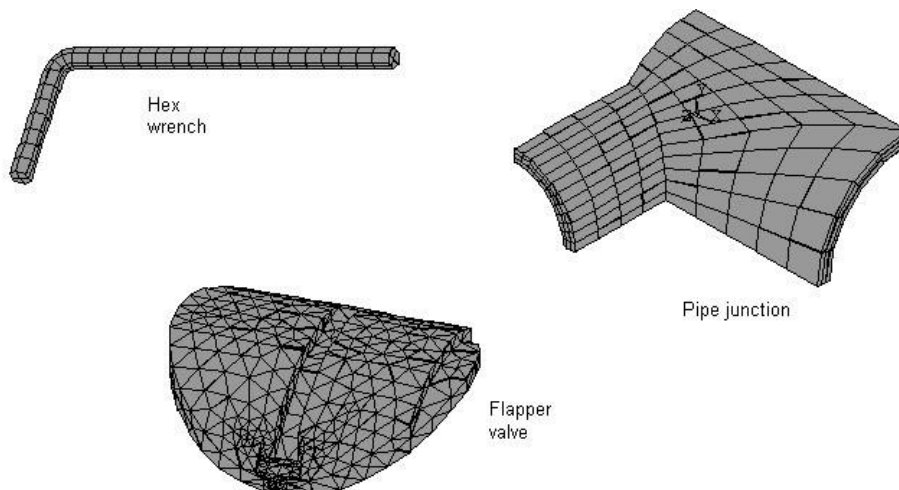

Apply Loads and Obtain the Solution:

In this step, you use the SOLUTION processor to define the analysis type and analysis options, apply loads, specify load step options, and initiate the finite element solution. You also can apply loads using the PREP7 preprocessor.

1. Defining the Analysis Type and Analysis Options:

You choose the analysis type based on the loading conditions and the response you wish to calculate. For example, if natural frequencies and mode shapes are to be calculated, you would choose a modal analysis. You can perform the following analysis types in the ANSYS program: static (or steady-state), transient, harmonic, modal, spectrum, buckling, and sub structuring.

Not all analysis types are valid for all disciplines. Modal analysis, for example, is not valid for a thermal model. The analysis guide manuals in the ANSYS documentation set describe the analysis types available for each discipline and the procedures to do those analyses.

Analysis options allow you to customize the analysis type. Typical analysis options are the method of solution, stress stiffening on or off, and Newton-Rap son options.

2. Applying Loads:

The word loads as used in ANSYS documentation includes boundary conditions (constraints, supports, or boundary field specifications) as well as other externally and internally applied loads. Loads in the ANSYS program are divided into six categories:

- i. DOF Constraints
- ii. Forces
- iii. Surface Loads
- iv. Body Loads
- v. Inertia Loads
- vi. Coupled-field Loads

You can apply most of these loads either on the solid model (key points, lines, and areas) or the finite element model (nodes and elements).

3. Specifying Load Step Options:

Load step options are options that you can change from load step to load step, such as number of sub steps, time at the end of a load step, and output controls. Depending on the type of analysis you are doing, load step options may or may not be required. The analysis procedures in the analysis guide manuals describe the appropriate load step options as necessary.

1. Initiating the Solution:

To initiate solution calculations, use either of the following:

Command(s):	SOLVE
	Main Menu> Solution> Solve> Current LS Main Menu> Solution> solution method

Review the Results:

Once the solution has been calculated, you can use the ANSYS postprocessors to review the results. Two postprocessors are available: POST1 and POST26.

You use POST1, the general postprocessor, to review results at one sub step (time step) over the entire model or selected portion of the model. The command to enter POST1 is /POST1 (Main Menu> General Postproc), valid only at the Begin level. You can obtain contour displays, deformed shapes, and tabular listings to review and interpret the results of the analysis. POST1 offers many

other capabilities, including error estimation, load case combinations, calculations among results data, and path operations.

You use POST26, the time history postprocessor, to review results at specific points in the model over all time steps. The command to enter POST26 is /POST26 (Main Menu> Timeliest Postpro), valid only at the Begin level. You can obtain graph plots of results data versus time (or frequency) and tabular listings. Other POST26 capabilities include arithmetic calculations and complex algebra.

Result:

Thus the basic steps to perform the analysis in ANSYS like

- a. Build the model.
- b. Apply loads and obtain the solution.
- c. Review the results are studied.

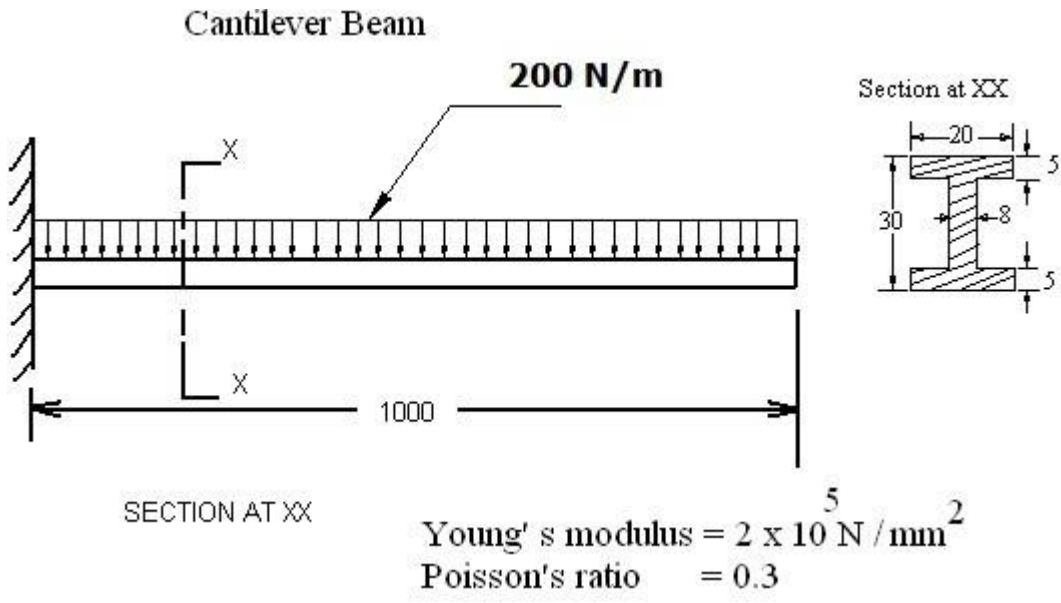

Observation:-

Load Vector

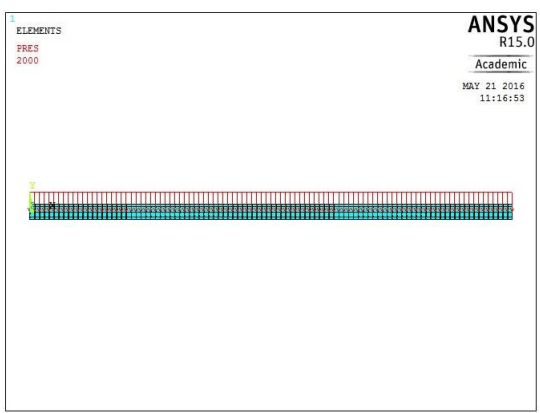

Deformed + Undeform shape

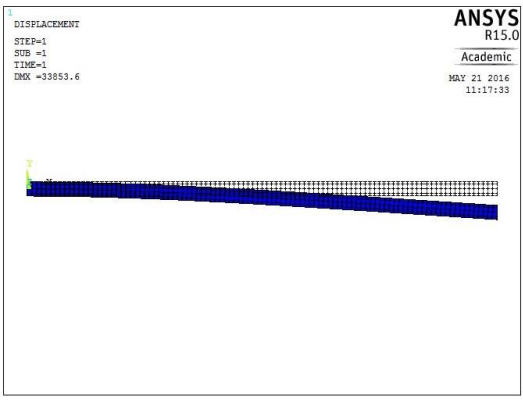

Ex.No	03	STATIC ANALYSIS OF CANTILEVER BEAM WITH UNIFORMLY DISTRIBUTED LOAD
Date		

Aim:-

To perform static analysis of given cantilever beam with uniformly distributed load by using ANSYS 15.0 analysis software.

System Configuration:-

Requirements

System: Windows 10 (64 Bit)

Processor : Intel Core i3

Speed : 3.60 GHz

Ram : 4 GB

HDD : 1 TB

Software

ANSYS 15.0 software

Procedure:-

It involves three basic types of operations.

1. Pre Processing
2. Solution
3. Post Processing

Preprocessing:-

1. Structural / h – method/structural
2. Preprocessor/Element type/Add/edit/delete/Add/ Beam/ 2 nodes 188/ok/close
3. Material props/material models/structural/linear/elastic/isotropic/ $E_{xx} = 2e5$ / $\nu_{xy} = 0.3$ /ok/close.
4. Sections / Beam/Common section/Sub type -I section/Enter the dimension $W1=20$, $W2=20$, $W3=30$, $t1=5$, $t2=5$ and $t3 = 8$ mm/ok/close
5. Modeling/Create/key points/ Inactive CS/ $x=0$ $y=0$ $z =0$ /Apply/ $x=1000$ $y=0$ $z=0$ /Apply $x=0$ $y=50$ $z=0$ /ok.
6. Modeling/Create/Lines/lines/In Active Coord/Select keypoint1 and track the mouse into select key point 2.
7. Meshing/mesh tool/Element attributes/select line/set/pick orientation key point is yes/ select key point 3/ok.
8. Meshing /mesh tool/size controls/lines/set/select line/Enter the value no of division=100 or element length is 10/ok.
9. Meshing /mesh tool/mesh/select the line/ok.

Deflection

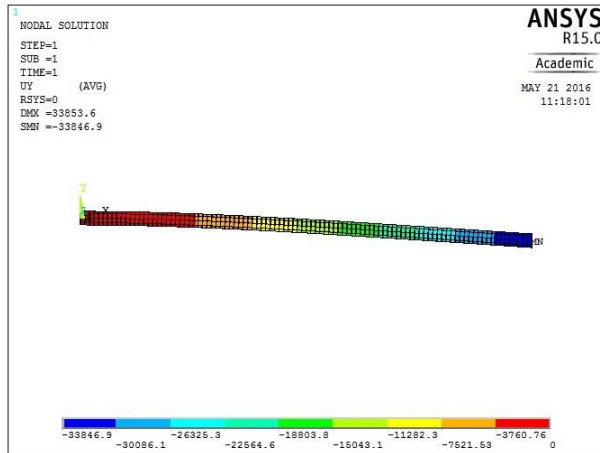

Shear Force Diagram

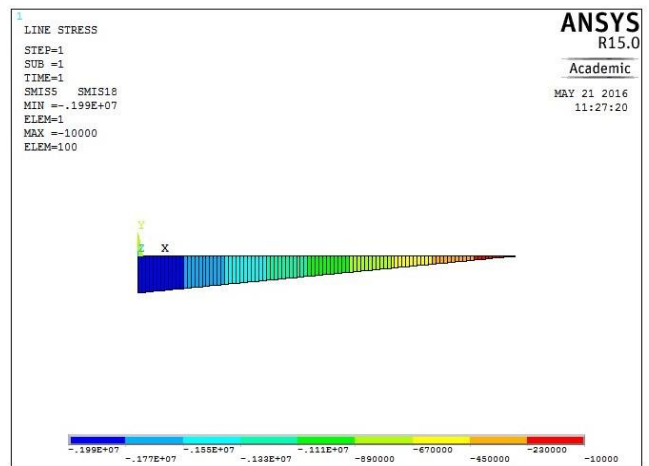

Slope

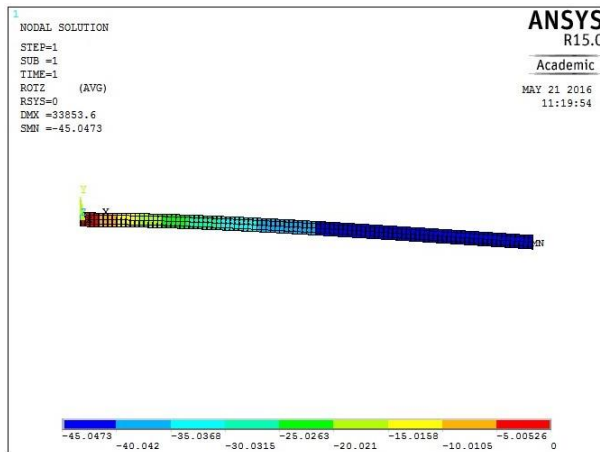

Bending Moment Diagram

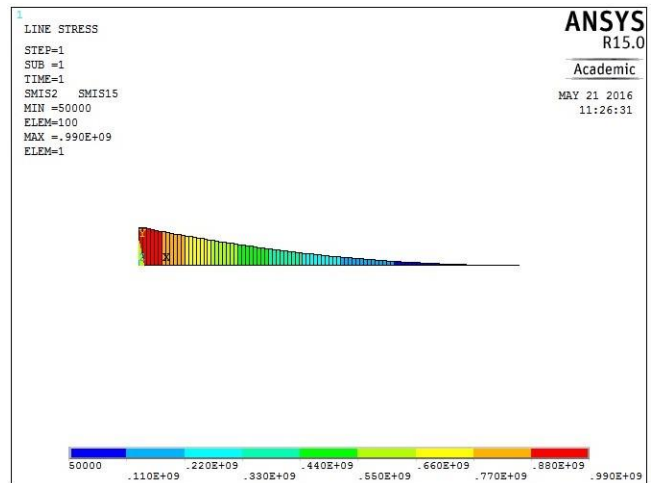

Von mises Stress

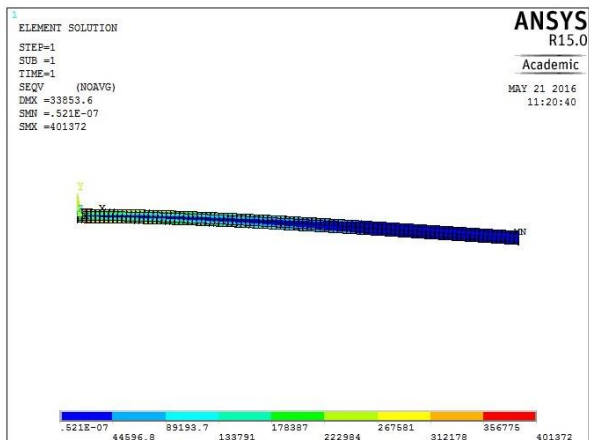

Solution:-

- 10. Solution/Define Loads /Apply/Structural / Displacement /on key points/select key point1 /All dof/ok.
- 11.Solution/Define Loads /Apply/Structural / Pressure/on beams/Pick all/enter the pressure value of I = 2000/ok.
- 12. Solutions/solve/current LS/solution is done.

Post Processing:-

- 13. Plot results for deformed/ Def + unreformed shape/plot controls/capture image.
- 14.Plot results for Contour plot/Nodal solu/Nodal solution/DOF solution/ Y component of displacement. /plot controls/capture image.
- 15.Plot results for Contour plot/Nodal solu/Nodal solution/DOF solution/ Z component of rotation. /plot controls/capture image.
- 16.Plot results for Contour plot/Nodal solu/Nodal solution/stress/ Vonmises stress/ok. /plot controls/capture image.
- 17.Element table/define table/Add/by sequence num / SMISC5 / Apply/ SMISC18 / Apply/SMISC 2/Apply/SMISC 15/ok.
- 18. Plot results /contour plot/ line element results/select SMISC 5 & SMISC 18/ ok. **SFD** will be plotted. /plot controls/capture image.
- 19. Plot results /contour plot/ line element results/select SMISC 2 & SMISC 15/ ok. **BMD** will be plotted. /plot controls/capture image.

Nodal solution:-

S.No	Parameters	Maximum	Minimum
1	Deflection in mm		
2	Strain		
3	Bending Stress in N/mm ²		
4	Bending Moment in N-mm		
5	Shear Force in N		

Result:-

Thus the static analysis of a cantilever beam was performed by using ANSYS 15.0 analysis software.

SIMPLY SUPPORTED BEAM

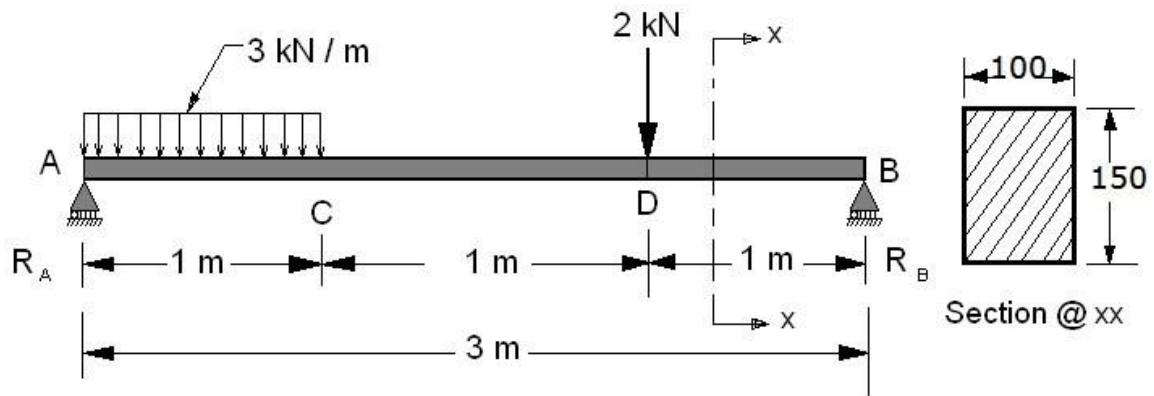

Load Vector

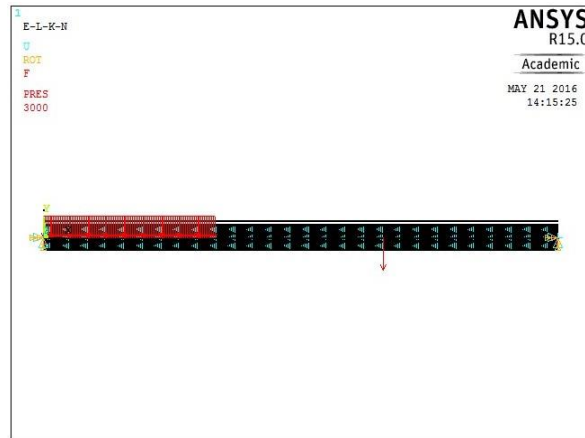

Def + Un deformed shape

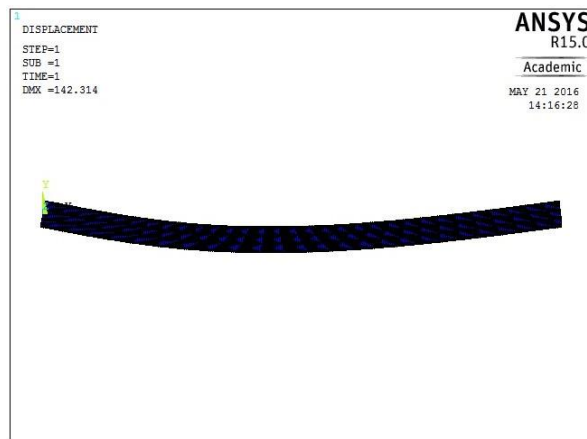

Ex.No	04	STATIC ANALYSIS OF SIMPLY SUPPORTED BEAM WITH UNIFORMLY DISTRIBUTED LOAD AND POINT LOAD
Date		

Aim:-

To perform static analysis of given simply supported beam with point load and uniformly distributed load by using ANSYS 15.0 analysis software.

System Configuration:

System : Windows 10 (64 Bit)

Processor : Intel Core i3

Speed : 3.60 GHz

Ram : 4 GB

HDD : 1 TB

Software

ANSYS 15.0 software

Procedure:-

It involves three basic types of operations.

1. Pre Processing
2. Solution
3. Post Processing

Preprocessing:-

1. Structural / h – method/structural
2. Preprocessor/Element type/Add/edit/delete/Add/ Beam/ 2 nodes 188/ok/close
3. Material props/material models / structural / linear / elastic / isotropic / Exx=1.9e5 /PRxy=0.25/ok/close
4. Sections / Beam/Common section/Sub type –square /Enter the dimension b=100,h=150, Nb=5 and Nh=5 /ok/close
5. Modeling/Create/key points/ Inactive CS/x=0 y=0 z =0/Apply/x=3000 y=0 z=0/Apply x=0 y=160 z=0/ok.
6. Modeling/Create/Lines/lines/In Active Coord/*Select keypoint1 and track the mouse into select key point 2.*
7. Meshing/mesh tool/Element attributes/*select line/set/pick orientation key point is yes/ select key point 3/ok.*
8. Meshing /mesh tool/size controls/lines/set/*select line/Enter the value no of division=100 or element length is 10/ok.*
9. Meshing /mesh tool/mesh/*select the line/ok.*

Deflection

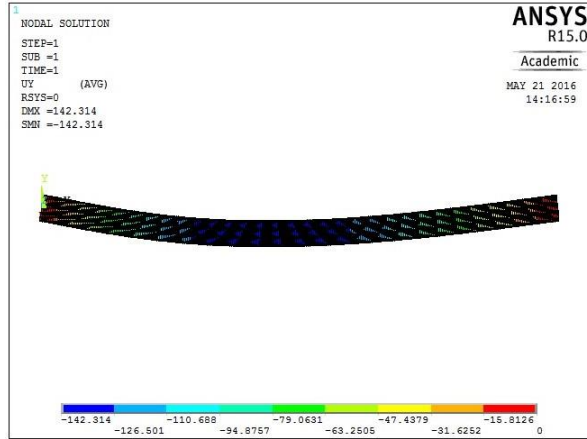

Stress

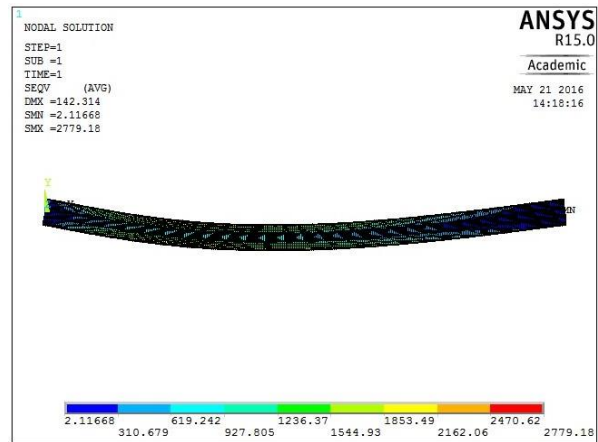

Slope

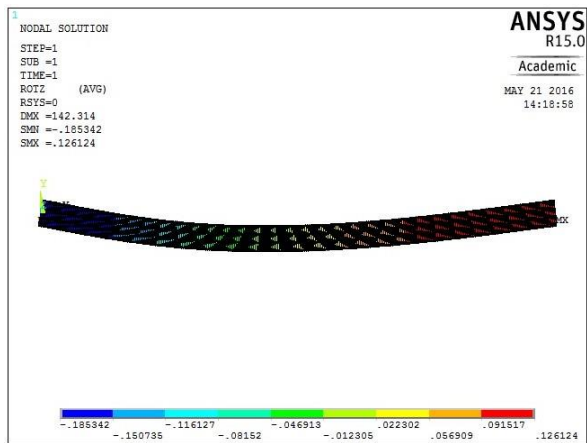

Solution:-

10. Solution/Define Loads /Apply/Structural / Displacement /on key points/*select key point 1 and 2/leave RotZ, All DOF and select others/ok.*

11. Solution/Define Loads /Apply/Structural / Pressure/on beams/*Pick first 100 elements/enter the pressure value of $I = 3000/ok.$*

Solution/Define Loads /Apply/Structural / Force/moment/on nodes /*Pick 200th nodes /enter the value $F_y = -2000/ok.$*

12. Solutions/solve/current LS/*solution is done.*

Post Processing:-

13. Plot results for deformed/ Def + unreformed shape/*plot controls/capture image.*

14. Plot results for Contour plot/Nodal solu/Nodal solution/DOF solution/ Y component of displacement. */plot controls/capture image.*

15. Plot results for Contour plot/Nodal solu/Nodal solution/DOF solution/ Z component of rotation. */plot controls/capture image.*

16. Plot results for Contour plot/Nodal solu/Nodal solution/stress/ Vonmises stress/*ok. /plot controls/capture image.*

17. Plot results for Contour plot/Nodal solu/Nodal solution/stress/ Vonmises stress/*ok. /plot controls/capture image.*

18. Element table/define table/Add/by sequence num / SMISC5 / Apply/ SMISC18 / Apply/SMISC 2/Apply/SMISC 15/*ok.*

19. Plot results /contour plot/ line element results/*select SMISC 5 & SMISC 18/ ok. SFD will be plotted. /plot controls/capture image.*

20. Plot results /contour plot/ line element results/*select SMISC 2 & SMISC 15/ ok. BMD will be plotted. /plot controls/capture image*

Shear Force Diagram

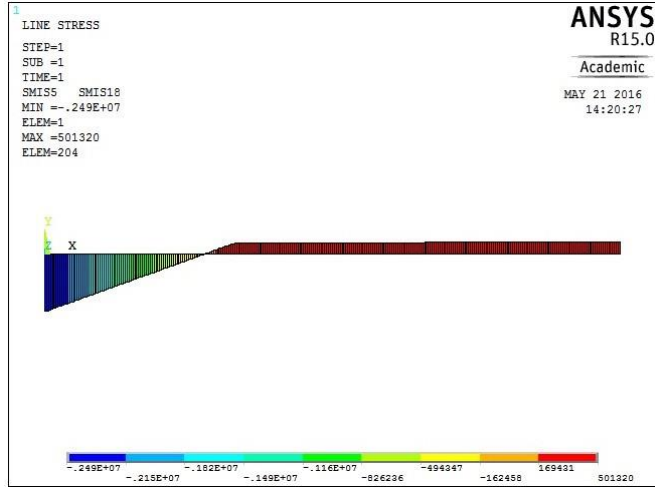

Bending Moment Diagram

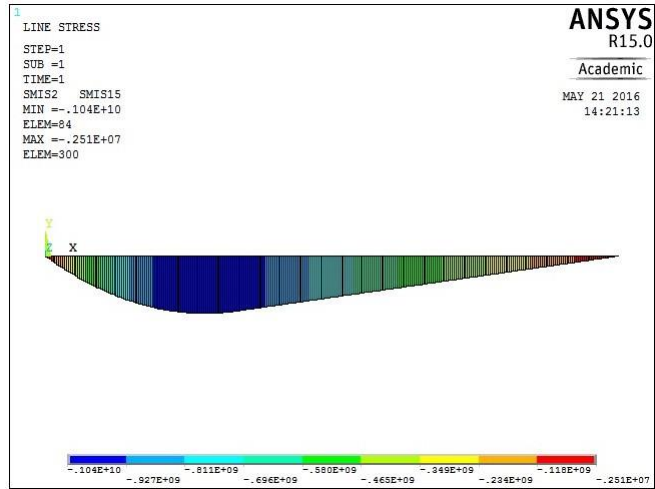

Nodal solution:-

S.No	Parameters	Maximum	Minimum
1	Deflection in mm		
2	Slope in radian		
3	Stress in N/mm ²		
4	Bending Moment in N-mm		
5	Shear Force in N		

Result:-

Thus the static analysis of given simply supported beam was performed by using ANSYS 15.0 analysis software.

FIXED BEAM

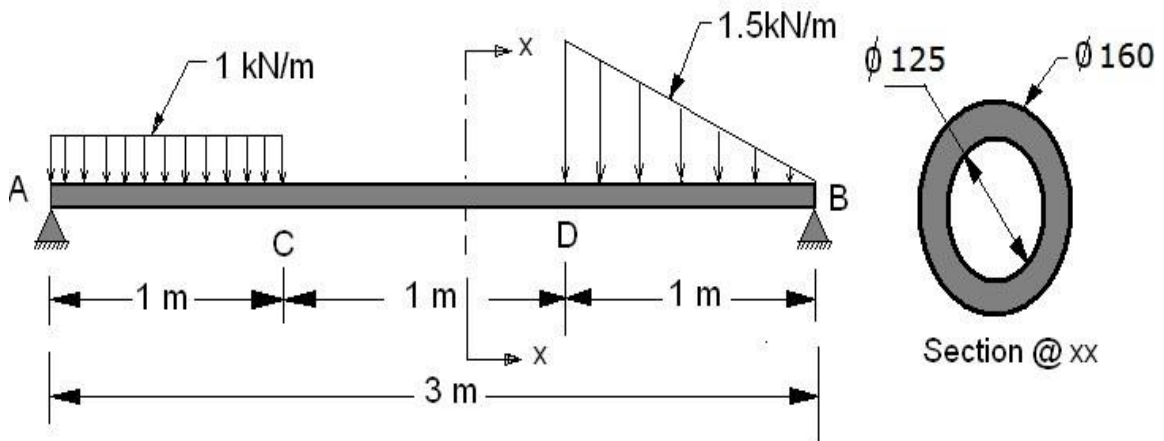

Young's Modulus = 150 GPa
Poisson's ratio = 0.3

Load Vector

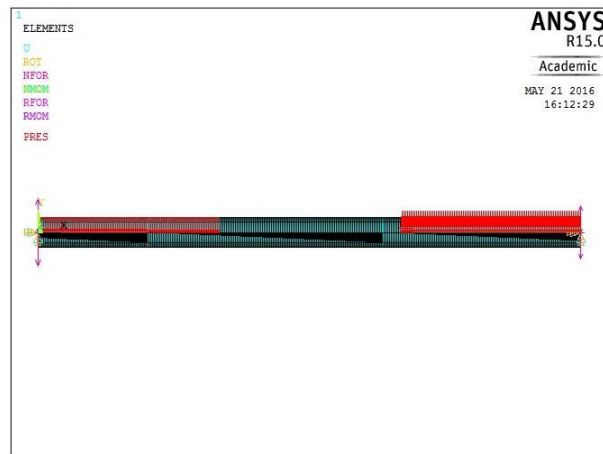

Def + Un deformed shape

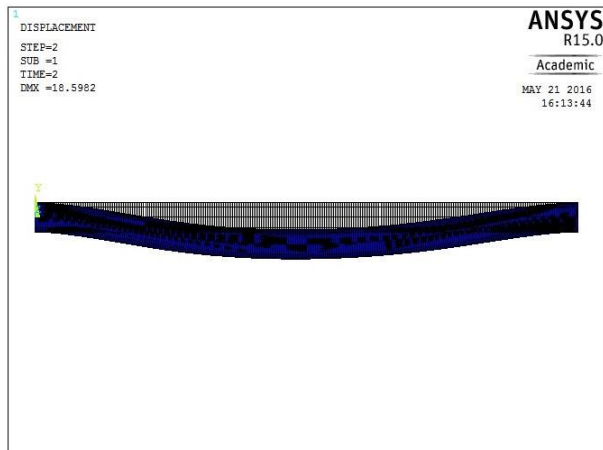

Ex.No	07	STATIC ANALYSIS OF FIXED BEAM WITH UDL AND UVL
Date		

Aim:-

To perform static analysis of given fixed beam with point load by using ANSYS 15.0 analysis software.

System Configuration:-

System : Windows 10 (64bit)
 Processor : Intel Core i3
 Speed : 3.60 GHz
 Ram : 4 GB
 HDD : 1 TB

Software

ANSYS 15.0 software

Procedure:-

It involves three basic types of operations

1. Pre Processing
2. Solution
3. Post Processing

Preprocessing:-

1. Structural / h – method/structural
2. Preprocessor/Element type/Add/edit/delete/Add/ Beam/ 2 nodes 188/ok/close
3. Material props/material models / structural / linear / elastic / isotropic / Exx=1.5e5 /PRxy=0.28/ok/close
4. Sections / Beam/Common section/Sub type -I section/Enter the dimension Do=160,Di=125, Nb=5 and Nh=5 /ok/close
5. Modeling/Create/key points/ Inactive CS/x=0 y=0 z =0/Apply/x=3000 y=0 z=0/Apply x=0 y=160 z=0/ok.
6. Modeling/Create/Lines/lines/In Active Coord/Select keypoint1 and track the mouse into select key point 2.
7. Meshing/mesh tool/Element attributes/select line/set/pick orientation key point is yes/ select key point 3/ok.
8. Meshing /mesh tool/size controls/lines/set/select line/Enter the value no of division=100 or element length is 10/ok.
9. Meshing /mesh tool/mesh/select the line/ok.

Deflection

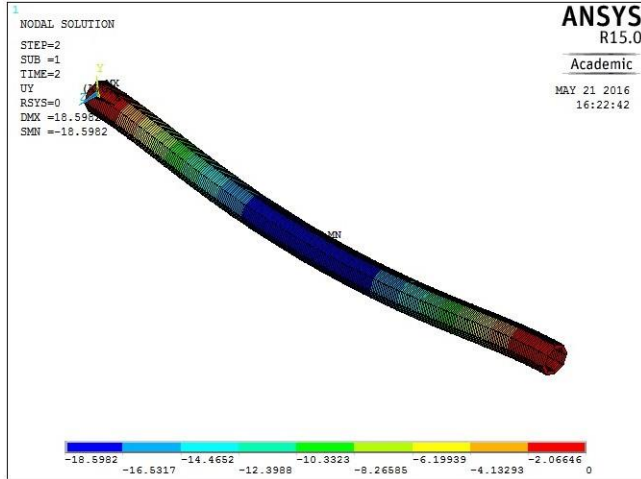

Stress

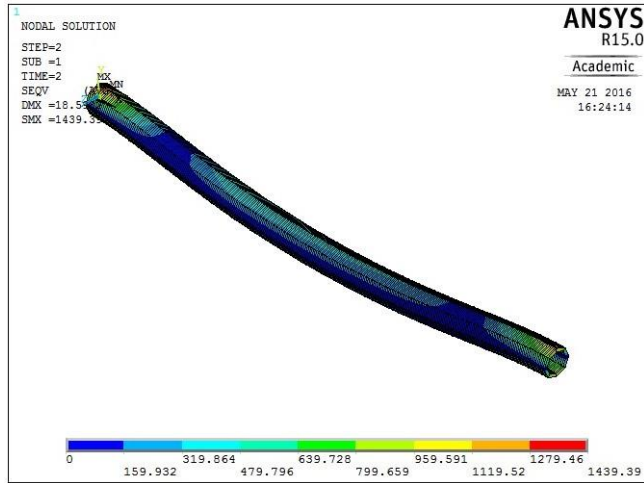

Slope

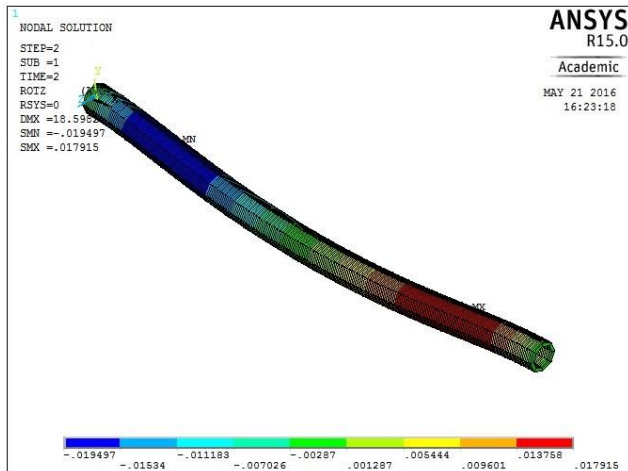

Solution:-

10. Solution/Define Loads /Apply/Structural / Displacement /on key points/*select key point 1 and 2/Select All DOF /ok.*

11. Solution/Define Loads /Apply/Structural / Pressure/on beams/Pick first 100 elements/*enter the pressure value of I = 1000/ok.*

Solution/Define Loads /Apply/Structural / Pressure/on beams/Pick last 100 elements/*enter the pressure value of I = 0 and J = 1500/ok.*

12. Solutions/solve/current LS/*solution is done.*

Post Processing:-

13. Plot results for deformed/ Def + unreformed shape/*plot controls/capture image.*

14. Plot results for Contour plot/Nodal solu/Nodal solution/DOF solution/ Y component of displacement. */plot controls/capture image.*

15. Plot results for Contour plot/Nodal solu/Nodal solution/DOF solution/ Z component of rotation. */plot controls/capture image.*

16. Plot results for Contour plot/Nodal solu/Nodal solution/stress/ Vonmises stress/*ok. /plot controls/capture image.*

17. Plot results for Contour plot/Nodal solu/Nodal solution/stress/ Vonmises stress/*ok. /plot controls/capture image.*

18. Element table/define table/Add/by sequence num / SMISC5 / Apply/ SMISC18 / Apply/SMISC 2/Apply/SMISC 15/*ok.*

19. Plot results /contour plot/ line element results/*select SMISC 5 & SMISC 18/ ok. SFD* will be plotted. */plot controls/capture image.*

20. Plot results /contour plot/ line element results/*select SMISC 2 & SMISC 15/ ok. BMD* will be plotted. */plot controls/capture image*

Shear Force Diagram

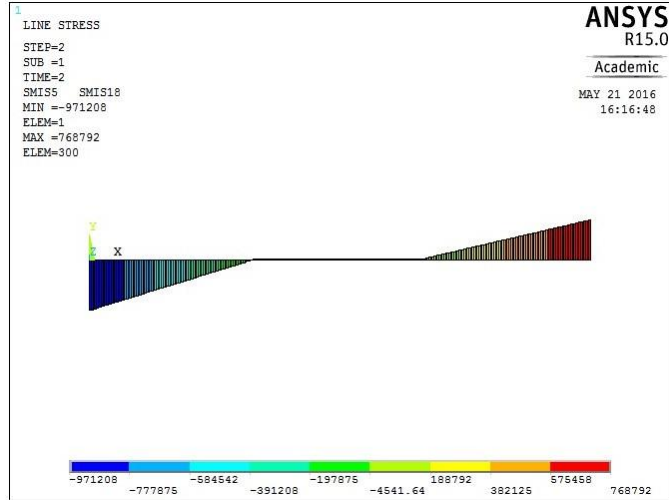

Bending Moment Diagram

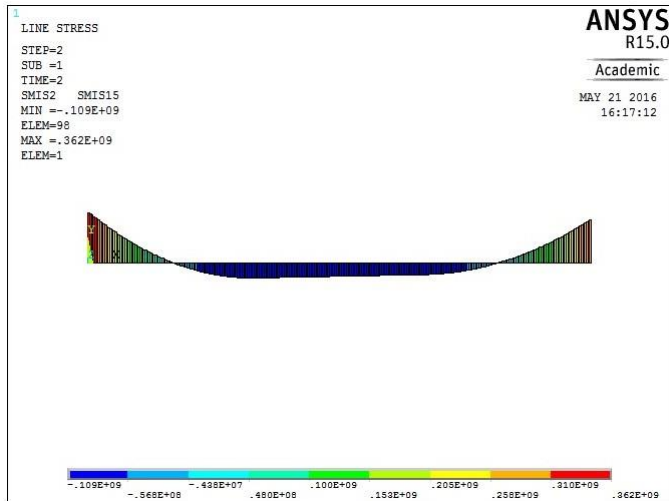

Nodal solution:-

S.No	Parameters	Maximum	Minimum
1	Deflection in mm		
2	Slope in radian		
3	Stress in N/mm ²		
4	Bending Moment in N-mm		
5	Shear Force in N		

Result:-

Thus the static analysis of given fixed beam was performed by using ANSYS 15.0 analysis software.

Ex.No	06	STATIC ANALYSIS OF A 2D TRUSS ELEMENT
Date		

Aim:-

To perform static analysis of given 2D truss element using ANSYS 15.0 analysis software.

System Configuration:-

System : Windows 10 (64 Bit)
 Processor : Intel Core i3
 Speed : 3.60 GHz
 Ram : 4 GB
 HDD : 1 TB

Software

ANSYS 15.0 software

Procedure:-

It involves three basic types of operations

1. Pre Processing
2. Solution
3. Post Processing

Preprocessing:-

1. Structural / h – method/structural
2. Preprocessor/Element type/Add/edit/delete/Add/ link/ 3D finite stn 180/ok/close
3. Real constants/Add//edit/delete/Add/ok/*Enter cross sectional area = 60*
4. Material props/material models / structural / linear / elastic / isotropic / $E_{xx}=2e9$ / $\nu_{xy}=0.3$ /ok/close.
5. Modeling/Create/Nodes/ Inactive CS/ $x=0$ $y=0$ $z=0$ /Apply/ $x=50$ $y=0$ $z=0$ / Apply / $x=100$ $y=0$ $z=0$ / Apply / $x=150$ $y=0$ $z=0$ / Apply / $x=125$ $y=50$ $z=0$ / Apply / $x=75$ $y=50$ $z=0$ / Apply / $x=25$ $y=50$ $z=0$ /ok.
6. Modeling/Create/elements/Auto numbered/Thru nodes/*Select keypoint1 and track the mouse into select key point 2.[similarly join all the points as per given truss diagram].*

Solution:-

7. Solution/Define Loads /Apply/Structural / Displacement /on key points/*select node1and node 2/Select All DOF /ok.*
8. Solution/Define Loads /Apply/Structural / Force/moment/*select nodes 5 and 7/enter the value $F_y = -100$ /Apply/ select node 6/enter the value $F_y = -200$ / Apply/select nodes 2 and 3/enter the value $F_y = -10$ /ok*
9. Solutions/solve/current LS/*solution is done.*

Deformation X – Displacement

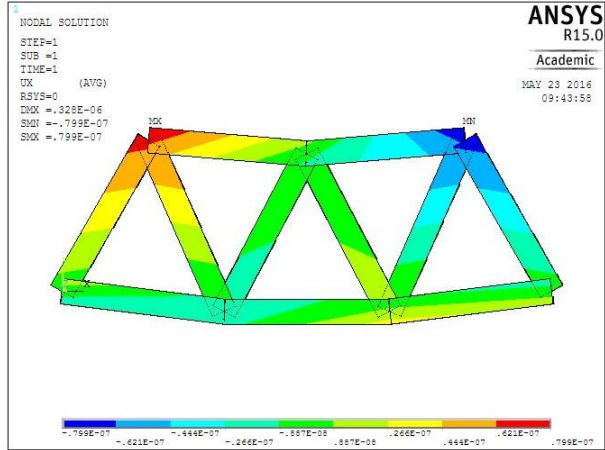

Y – Displacement

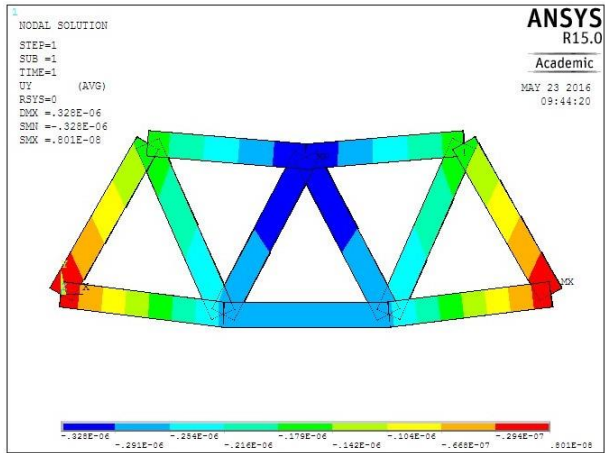

Element stresses

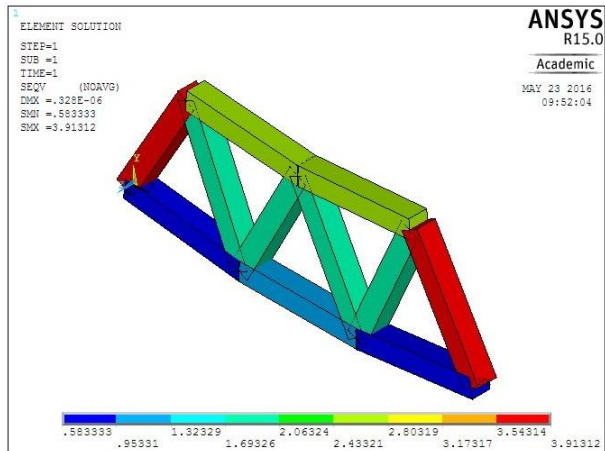

Post Processing:-

10. Plot results for deformed/ Def + unreformed shape/*plot controls/capture image.*
11. Plot results for Contour plot/Nodal solu/Nodal solution/DOF solution/ X component of displacement. */plot controls/capture image.*
12. Plot results for Contour plot/Nodal solu/Nodal solution/DOF solution/ Y component of displacement. */plot controls/capture image.*
13. Plot results for Contour plot/Element solution/stress/Von mises stress/*plot controls/capture image.*
14. Plot results for Contour plot/Element solution/Total mechanical strain/Von mises strain/*plot controls/capture image.*

Element strain

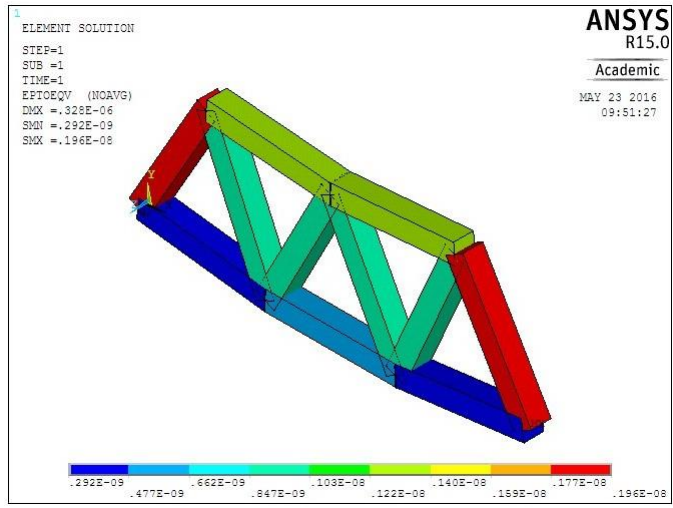

Nodal solution:-

S.No	Parameters	Maximum	Minimum
1	X Displacement in cm		
2	Y Displacement in cm		
3	Stress in N/cm ²		
4	Strain		

Result:-

Thus the static analysis of given 2D truss element was performed by using ANSYS 15.0 analysis software.

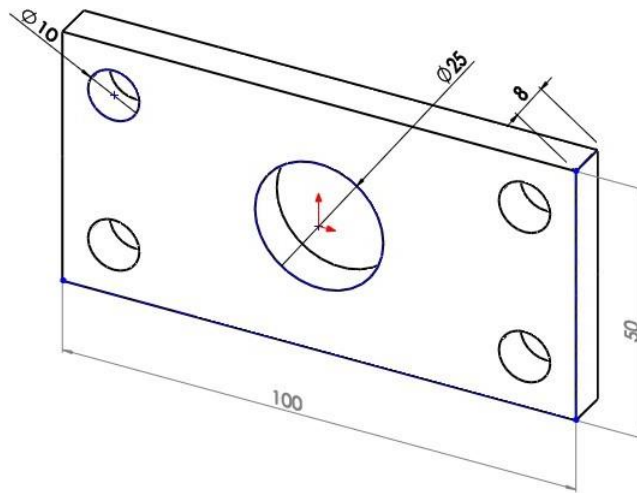

Young's Modulus = 150 GPa
 Poisson's ratio = 0.28

Observation:-

Load Vector

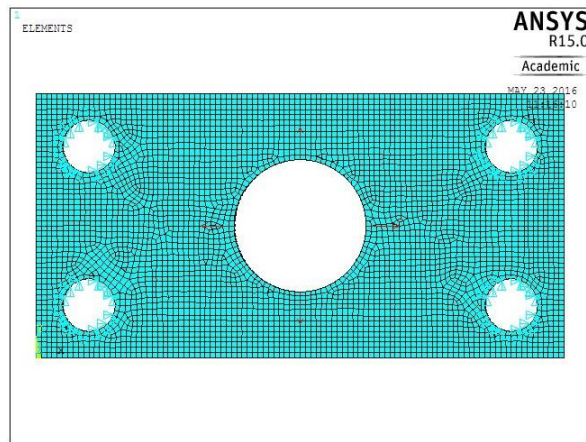

Def + undef shape

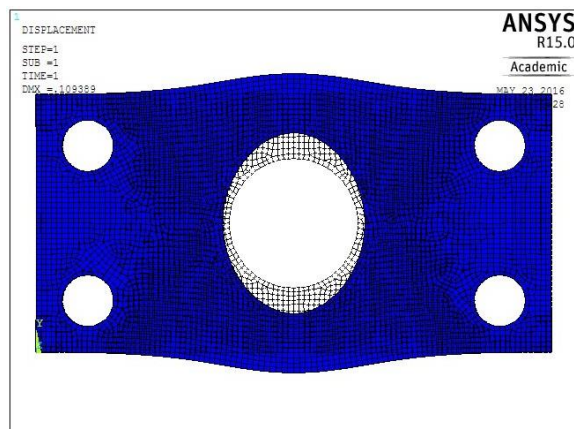

Ex.No	07	STATIC ANALYSIS OF A 2D PLATE COMPONENT
Date		

Aim:-

To perform static analysis of given 2D plate component by using ANSYS 15.0 analysis software.

System

Configuration:-

Requirements

System : Windows 10 (64 Bit)

Processor : Intel Core i3

Speed : 3.60 GHz

Ram : 4 GB

HDD : 1 TB

Software

ANSYS 15.0 software

Procedure:-

It involves three basic types of operations

1. Pre Processing
2. Solution
3. Post Processing

Preprocessing:-

1. Structural / h – method/structural
2. Preprocessor/Element type/Add/edit/delete/Add/ solid/ Quad 4 node 182/ok/options/plane stress with thk/ok/close
3. Real constants/Add//edit/delete/Add/ok/Enter cross thickness = 8
4. Material props/material models / structural / linear / elastic / isotropic / Exx=1.5e5 /PRxy=0.28/ok/close.
5. Modeling/Create/Area / rectangle/By 2 corner/X = 0, Y=0, Width = 100 and Height = 50/ok
6. Modeling/Create/Area/Solid circle/x= 50, y= 25 and radius = 12.5/ok
7. Modeling/operate/Booleans/subtract/select area 1/apply/select area 2/ok
8. Modeling/Create/area/solid circle/x= 10, y=10 and radius = 5/apply/x= 90, y=10 and radius = 5/apply/x= 90, y=40 and radius = 5/apply/x= 100, y=40 and radius = 5/ok.
9. Modeling/operate/Booleans/subtract/select area 1/apply/select area 3, 4, 5&6/ok

Solution:-

7. Solution/Define Loads /Apply/Structural / Displacement /on lines/select all small circle's periphery lines/ All DOF /ok.
8. Solution/Define Loads /Apply/Structural / pressure/on lines/select big circles' periphery lines enter the value of I = 500/ok

9. Solutions/solve/current LS/solution is done.

Displacement solution X- Displacement

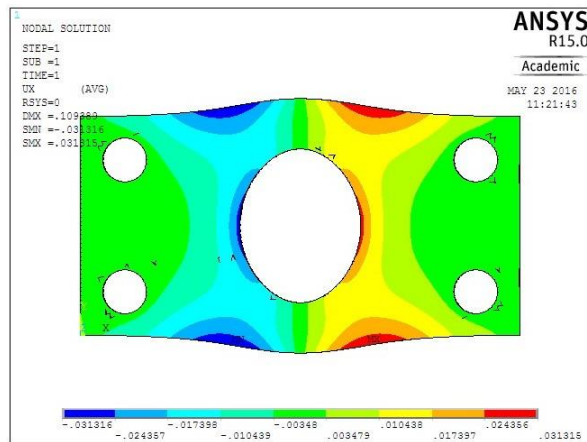

Y - Displacement

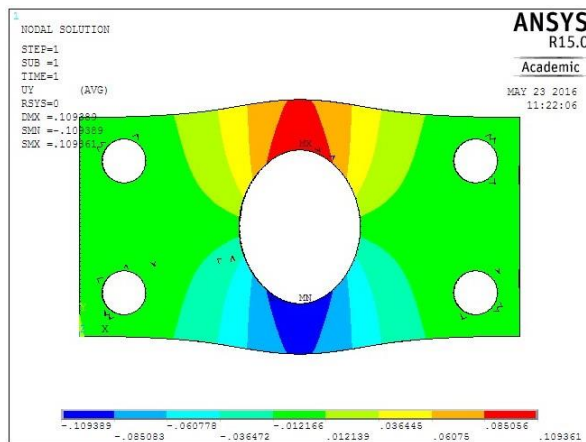

Element Stress solution

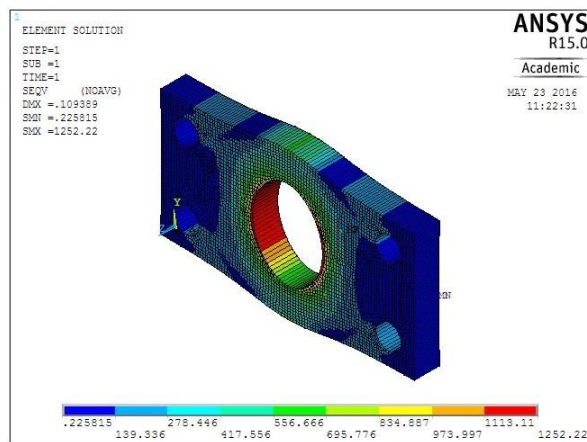

Post Processing:-

10. Plot results for deformed/ Def + unreformed shape/*plot controls/capture image.*
11. Plot results for Contour plot/Nodal solu/Nodal solution/DOF solution/ X component of displacement. */plot controls/capture image.*
12. Plot results for Contour plot/Nodal solu/Nodal solution/DOF solution/ Y component of displacement. */plot controls/capture image.*
13. Plot results for Contour plot/Element solution/stress/Von mises stress/*plot controls/capture image.*
14. Plot results for Contour plot/Element solution/Total mechanical strain/Von mises strain/*plot controls/capture image.*

Element Strain solution

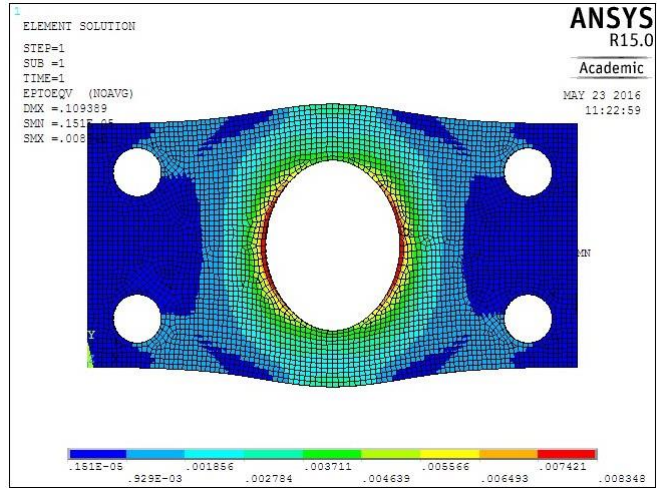

Nodal solution:-

S.No	Parameters	Maximum	Minimum
1	X Displacement in mm		
2	Y Displacement in mm		
3	Stress in N/mm ²		
4	Strain		

Result:-

Thus the static analysis of given 2D plate component was performed by using ANSYS 15.0 analysis software.

2D - 'L' BRACKET

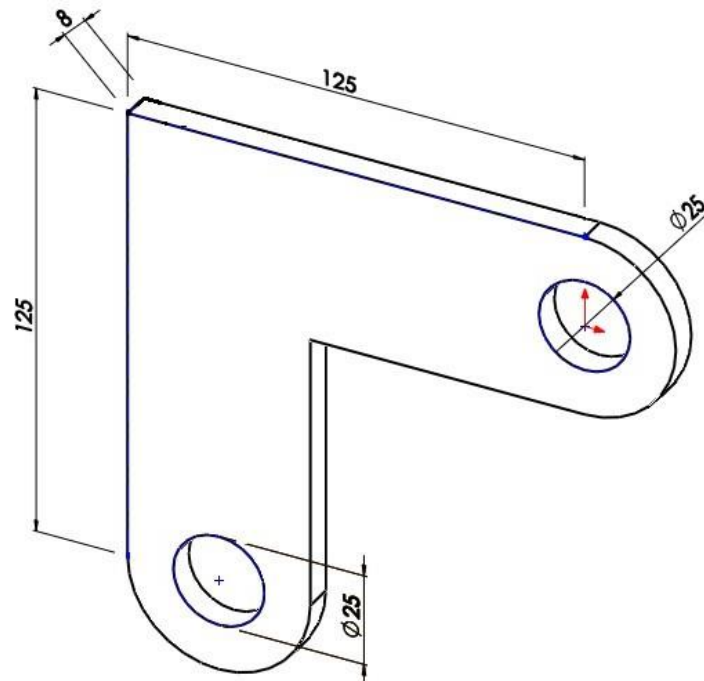

All Dimensions in mm

Young's modulus = 2×10^5 N/mm²
Poisson's ratio = 0.3

Observation:-

Load Vector

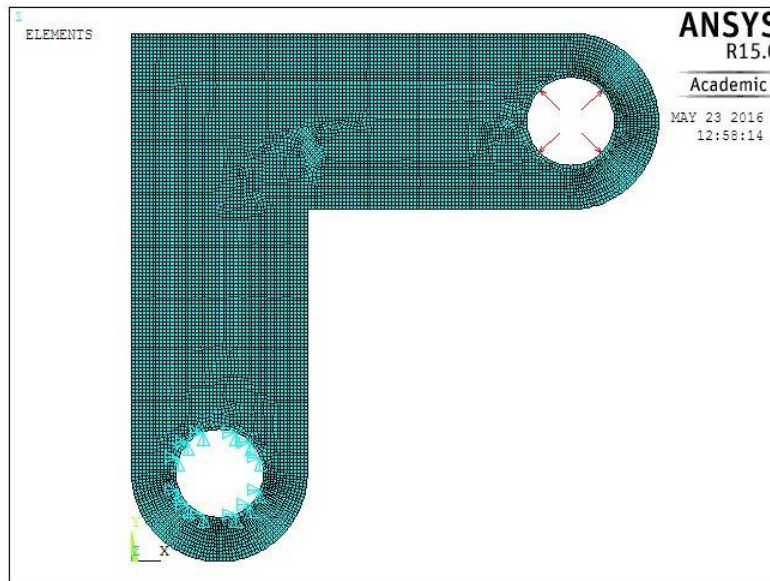

Ex.No	08	STATIC ANALYSIS OF A 2D L - BRACKET
Date		

Aim:-

To perform static analysis of given 2D L - bracket by using ANSYS 15.0 analysis software.

System

Configuration:-

Requirements

System : Windows 10 (64 Bit)

Processor : Intel Core i3

Speed : 3.60 GHz

Ram : 4 GB

HDD : 1 TB

Software

ANSYS 15.0 software

Procedure:-

It involves three basic types of operations

1. Pre Processing
2. Solution
3. Post Processing

Preprocessing

1. Structural / h - method/structural
2. Preprocessor/Element type/Add/edit/delete/Add/ solid/ Quad 4 node 182 / ok / options/plane stress with thk/ok/close
3. Real constants/Add//edit/delete/Add/ok/Enter cross thickness = 8
4. Material props/material models / structural / linear / elastic / isotropic / Exx=2e5 /PRxy=0.3/ok/close.
5. Modeling/Create/Area/Rectangle/By 2 corner/X = 0, Y=25, Width = 50 and Height = 125/apply/ X = 50, Y=100, Width = 75 and Height = 50/ok
6. Modeling/Create/Area/circle/Solid circle/x= 25, y= 25 and radius = 25/apply/ x= 125, y= 125 and radius = 25/ok.
7. Modeling/operate/Booleans/Add/select area 1(rectangle 1)and area 3(circle 1)/apply/select area 2(rectangle 2) and area 4(circle 2)/apply/select vertical area and horizontal area/ok
8. Modeling/Create/Area/circle/Solid circle/x= 25, y= 25 and radius = 12.5/apply/ x= 125, y= 125 and radius = 12.5/ok.
9. Modeling/operate/Booleans/subtract/select area 1/apply/select area 5(small circle 1)/apply/select area 2/apply select area 6(small circle 2)/ok
10. Meshing/mesh tool/size controls/area/set(click)/select area/enter element size = 2/ok
11. Meshing/mesh tool/ mesh/ select area/ok.

Observation:-

Def + undef shape

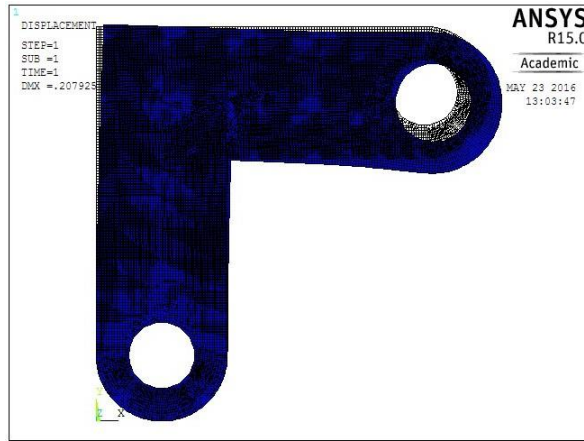

Displacement solution

X- Displacement



Y - Displacement

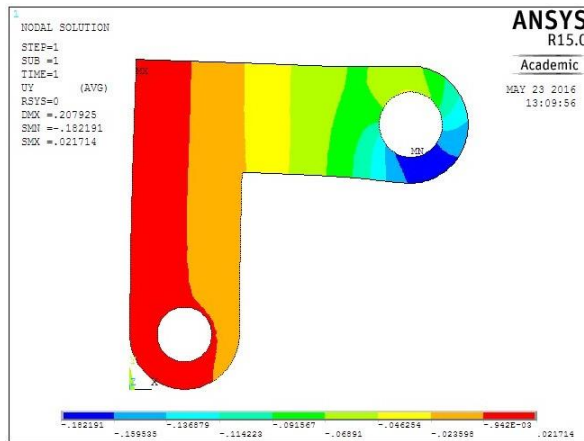

Solution:-

12. Solution/Define Loads /Apply/Structural / Displacement /on lines/*bottom hole's circle periphery lines*/ All DOF /ok.

13. Solution/Define Loads /Apply/Structural / pressure/on lines/*select top hole's circle periphery lines* enter the value of $I = 500$ /ok

14. Solution/Define Loads /Apply/Structural / Force/moment/on nodes/*select right side center node which is lies in upper hole*/enter the value $F_x = 1000$ /apply/ *select top bottom side center node which is lies in upper hole*/ $F_y = -1000$ /ok.

15. Solutions/solve/current LS/*solution is done.*

Post Processing:-

16. Plot results for deformed/ Def + unreformed shape/*plot controls/capture image.*

17. Plot results for Contour plot/Nodal solu/Nodal solution/DOF solution/ X component of displacement. /*plot controls/capture image.*

18. Plot results for Contour plot/Nodal solu/Nodal solution/DOF solution/ Y component of displacement. /*plot controls/capture image.*

19. Plot results for Contour plot/Element solution/stress/Von mises stress/*plot controls/capture image.*

20. Plot results for Contour plot/Element solution/Total mechanical strain/Von mises strain/*plot controls/capture image.*

Stress solution

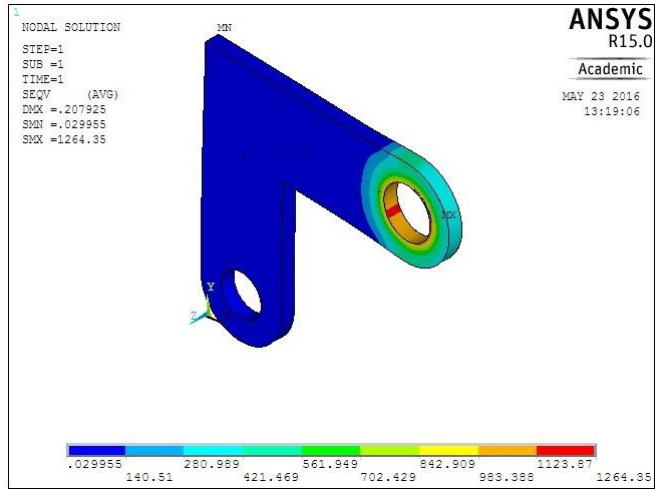

Strain solution

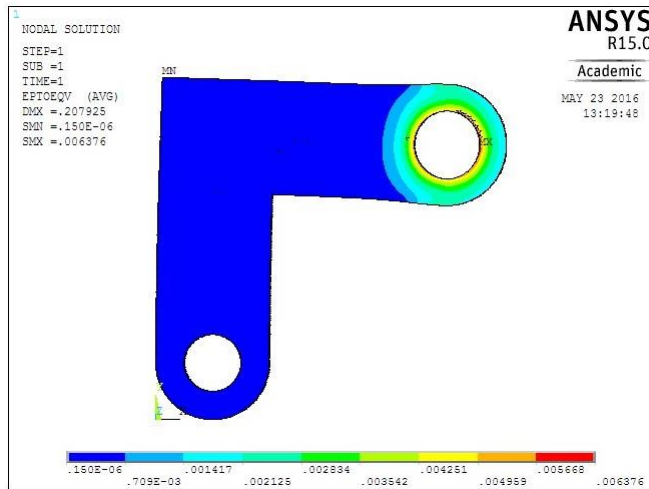

Nodal solution:-

S.No	Parameters	Maximum	Minimum
1	X Displacement in mm		
2	Y Displacement in mm		
3	Stress in N/mm ²		
4	Strain		

Result:-

Thus the static analysis of given 2D truss element was performed by using ANSYS 15.0 analysis software.

AXISYMMETRIC ELEMENT

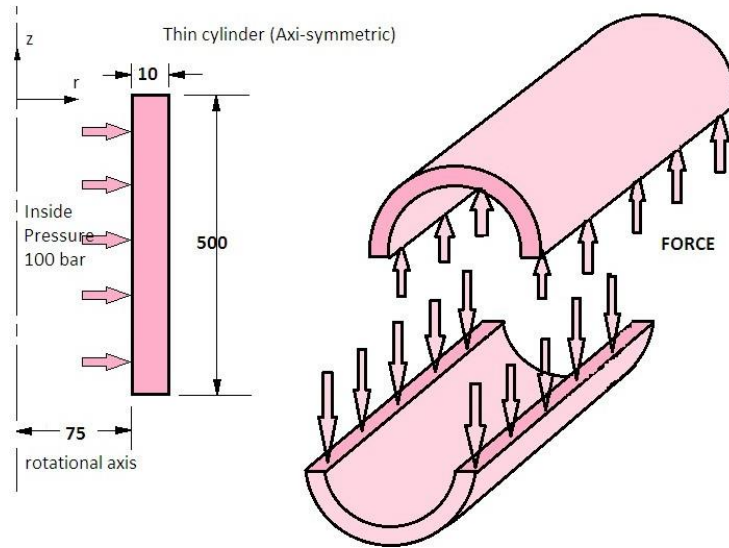

Boundary condition

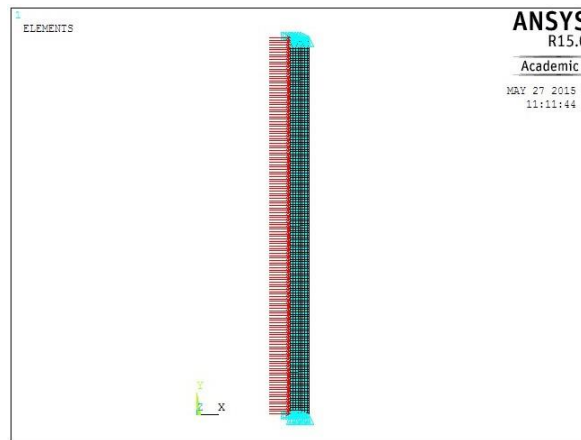

Def - 2D

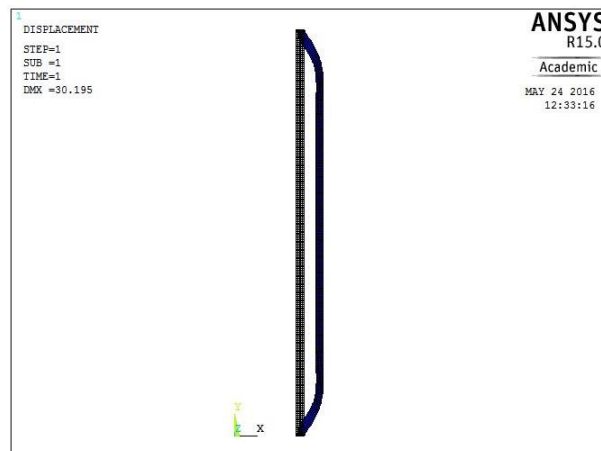

Ex.No	09	STATIC ANALYSIS OF AN AXI – SYMMETRIC COMPONENT
Date		

Aim:

To perform static analysis of thin cylindrical shell (axi-symmetric) component by using ANSYS 15.0 analysis software.

System

Configuration:-

Requirements

System : Windows 10 (64 Bit)

Processor : Intel Core i3

Speed : 3.60 GHz

Ram : 4 GB

HDD : 1 TB

Software

ANSYS 15.0 software

Procedure:-

It involves three basic types of operations

1. Pre Processing
2. Solution
3. Post Processing

Preprocessing

1. Structural / h – method/structural
2. Preprocessor/Element type/Add/edit/delete/Add/ solid/ Quad 4 node 182 / ok / options/Axisymmetric/ok/close
3. Material props/material models / structural / linear / elastic / isotropic / Exx=2e5 /PRxy=0.3/ok/close.
4. Modeling/Create/Area/Rectangle/By 2 corner/X = 75, Y=0, Width = 10 and Height = 500/ok.
5. Meshing/mesh tool/size controls/area/set(click)/select area/enter element size = 2/ok
6. Meshing/mesh tool/ mesh/ select area/ok.

Solution:-

7. Solution/Define Loads /Apply/Structural / Displacement /on lines/select top and bottom lines/All dof/ok
8. Solution/Define Loads /Apply/Structural /pressure/on lines/ select vertical inside line/ok/enter the pressure value = 10/ok
9. Solution/Solve/Current LS/ok/Solution is done.

Deformed shape – 3D



Displacement solution

X - Displacement

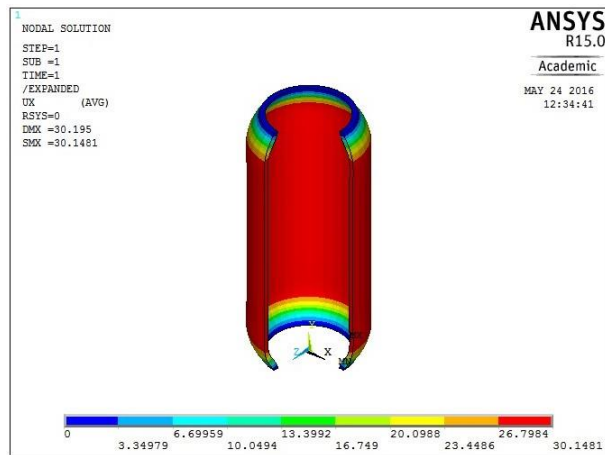

Y - Displacement

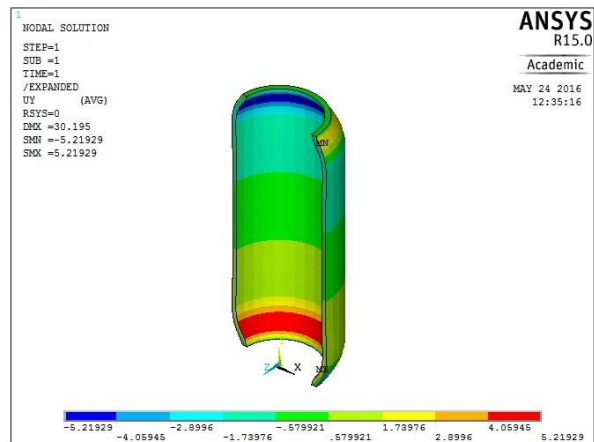

Post Processing:-

9. Plot results for deformed/ Def + unreformed shape/*plot controls/capture image.*

10. Plot results for deformed/ Def + unreformed shape/*plot controls/Style/size and shape/Display object /on/ok*

Plot controls/Style/size and shape/Symmetric expansion/2D axi-symmetric/select the options/ok/plot controls/capture image.

11. Plot results for Contour plot/Nodal solu/Nodal solution/DOF solution/ X component of displacement. */plot controls/capture image.*

12. Plot results for Contour plot/Nodal solu/Nodal solution/DOF solution/ Y component of displacement. */plot controls/capture image.*

13. Plot results for Contour plot/Nodal solution/stress/ X component of stress/*plot controls/capture image.*

14. Plot results for Contour plot/Nodal solution/stress/ Y component of stress/*plot controls/capture image.*

15. Plot results for Contour plot/Nodal solution/Total Mechanical strain/vonmises strain/*plot controls/capture image.*

Stress solutions Longitudinal stress

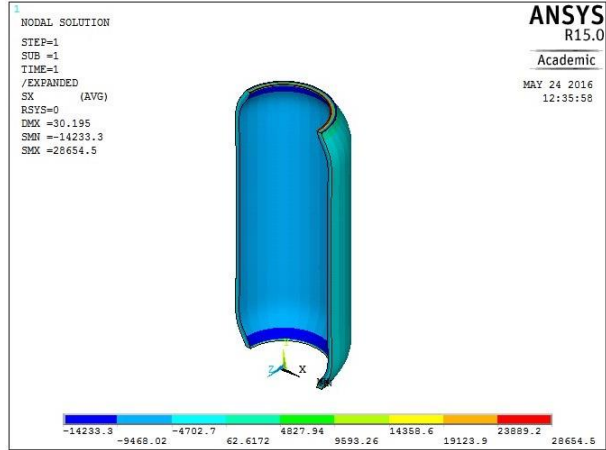

Circumferential stress

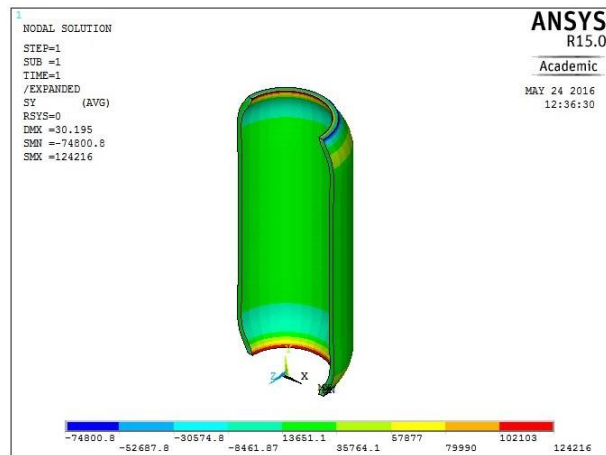

Strain solutions

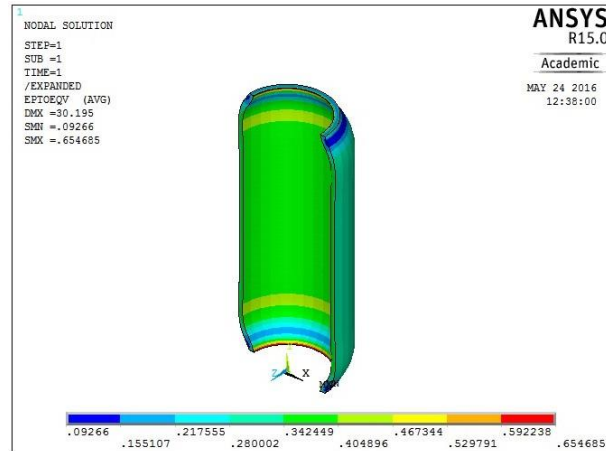

S.No	Parameters	Maximum	Minimum
1	X Displacement in mm		
2	Y Displacement in mm		
3	Longitudinal Stress in N/mm ²		
4	Circumferential stress in N/mm ²		
5	Strain		

Result:-

Thus the static analysis of Axisymmetric element was performed by using ANSYS 15.0 analysis software.

SIMPLY SUPPORTED BEAM

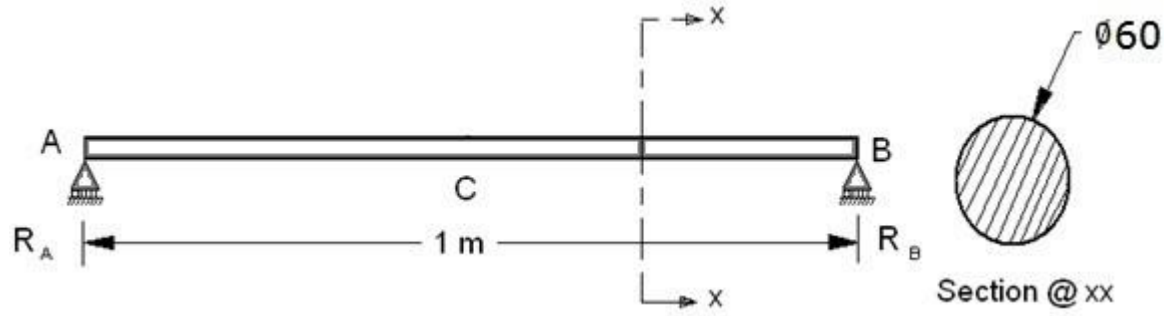

Load Vector

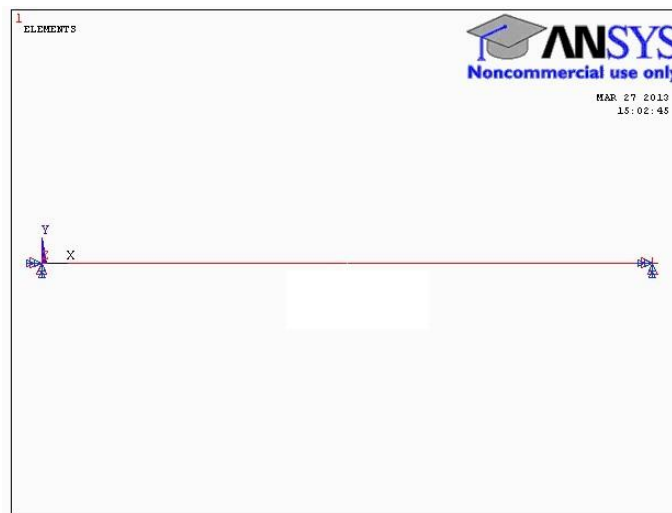

Meshing of Model

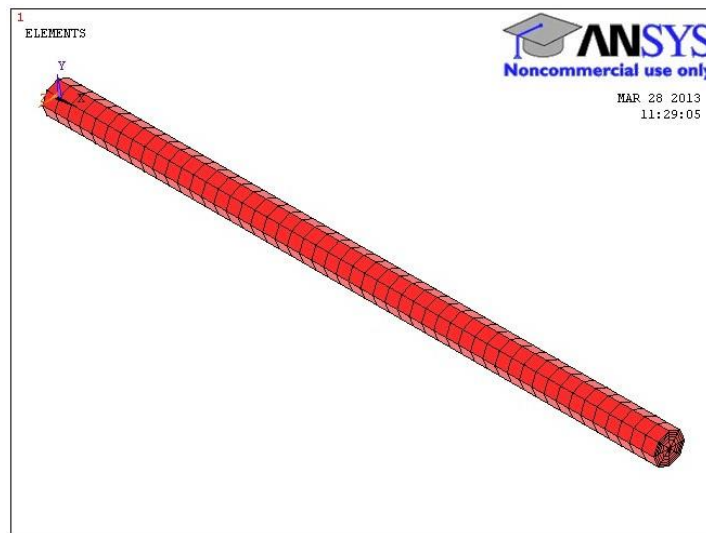

Ex.No	10	MODAL ANALYSIS ON A SIMPLY SUPPORTED BEAM
Date		

Aim:-

To perform modal analysis of given simply supported beam with point load by using ANSYS 15.0 analysis software.

System

Configuration:-

Requirements

System : Windows 10 (64 Bit)
 Processor : Intel Core i3
 Speed : 3.60 GHz
 Ram : 4 GB
 HDD : 1 TB

Software

ANSYS 15.0 software

Procedure:-

It involves three basic types of operations

1. Pre Processing
2. Solution
3. Post Processing

Preprocessing:-

1. Structural / h - method/structural
2. Preprocessor/Element type/Add/edit/delete/Add/ Beam/ 2 nodes 188/ok/close
3. Material props/Material library/ import library / Browse/[C-Drive/Program files/Ansys Inc/ v150 /ansys/ matlib /Stl_AISI-304.SI_MPL/ok
4. Sections / Beam/Common section/Sub type -solid circular /Enter the dimension R = 30 , N_b=5 and N_h=5 /ok/close
5. Modeling/Create/key points/ Inactive CS/x=0 y=0 z =0/Apply/x=1000 y=0 z=0/Apply x=0 y=75 z=0/ok.
6. Modeling/Create/Lines/lines/In Active Coord/Select keypoint1 and track the mouse into select key point 2.
7. Meshing/mesh tool/Element attributes/select line/set/pick orientation key point is yes/ select key point 3/ok.
8. Meshing /mesh tool/size controls/lines/set/select line/Enter the value no of division=100 or element length is 10/ok.
9. Meshing /mesh tool/mesh/select the line/ok.

Observation:-

First mode

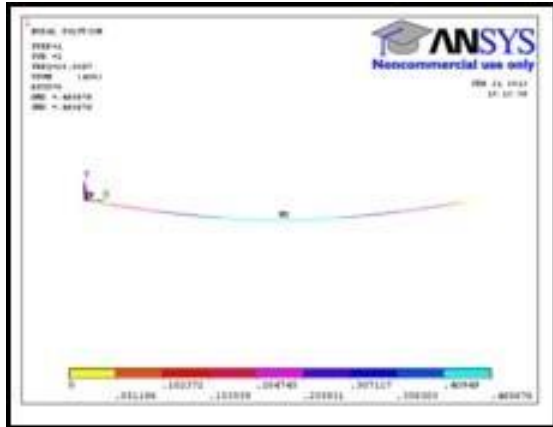

Solution:-

10. Solution/Analysis type/New analysis/Modal
11. Solution / Analysis type /Analysis options / No of modes to extract = 10 / No of modes to expand = 10 / ok / Start frequency = 0 / End frequency = 0
12. Define Loads /Apply/Structural / Displacement /on key points/*select key point 1 and 2/leave RotZ, All DOF and select others/ok.*
13. Solutions/solve/current LS/*solution is done.*

Post Processing:-

14. Read results/ first set.
15. Plot results for Contour plot/Nodal solu/Nodal solution/DOF solution/ Y component of displacement. */plot controls/capture image. (First mode of frequency)*
16. Read results/ next set. (second mode of frequency)
17. Plot results for Contour plot/Nodal solu/Nodal solution/DOF solution/ Y component of displacement. */plot controls/capture image.*
18. Repeat the above steps 16 & 17 for remaining 8 modes

Seventh mode

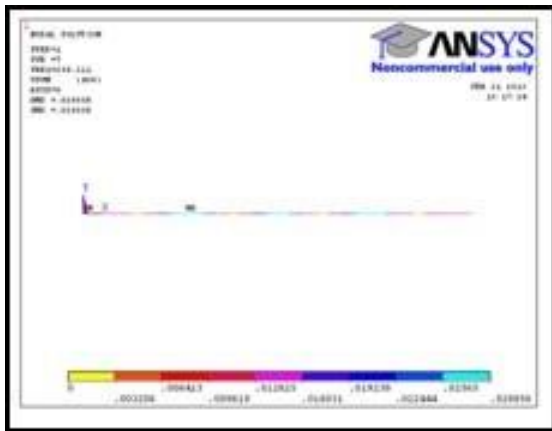

Eight mode

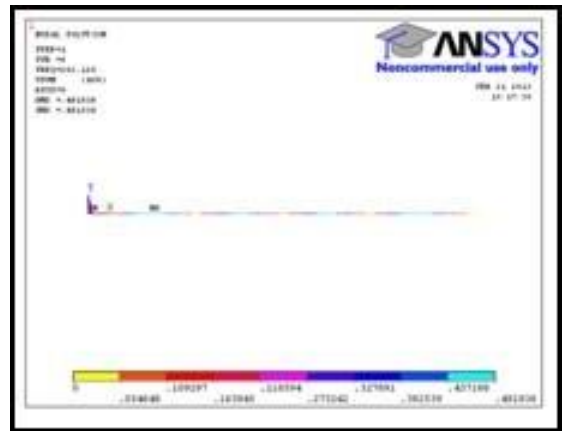

Ninth mode

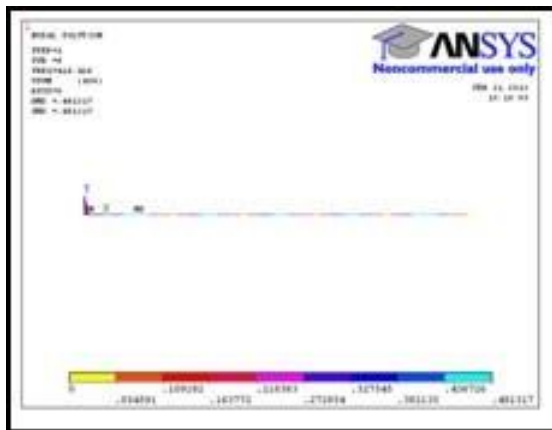

Tenth mode

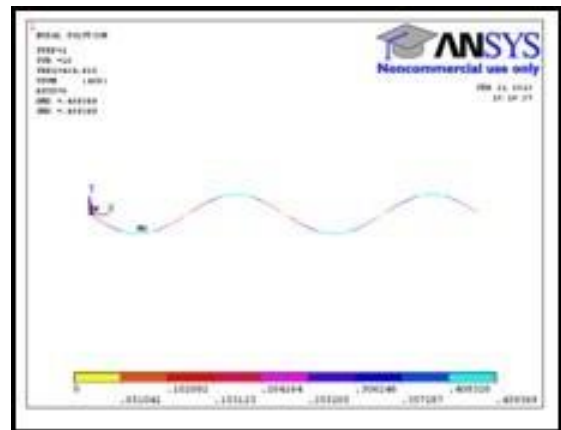

Frequency at different modes:-

Mode no	Frequency in Hz
1	
2	
3	
4	
5	
6	
7	
8	
9	
10	

Result:-

Thus the modal analysis of given simply supported beam was performed by using ANSYS 15.0 analysis software.

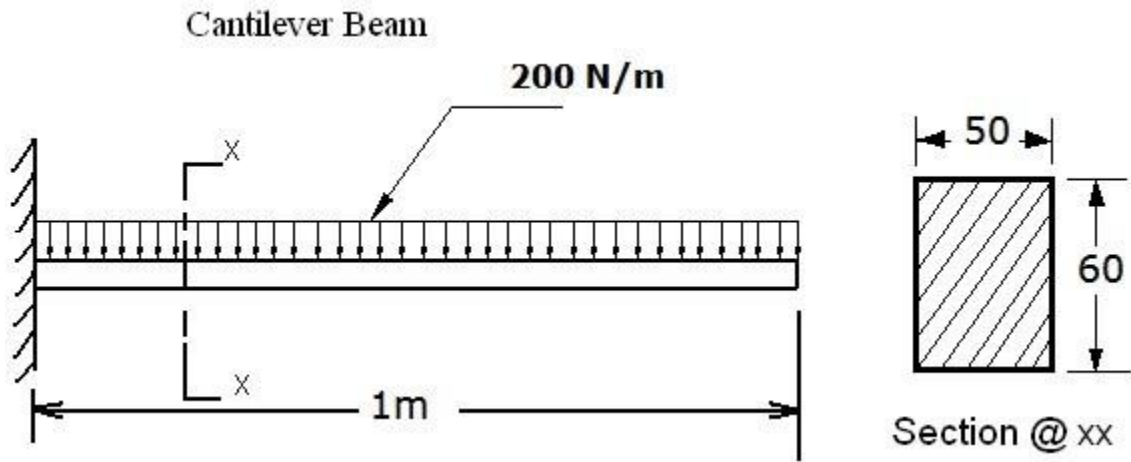

Observation:-

Meshing of Model

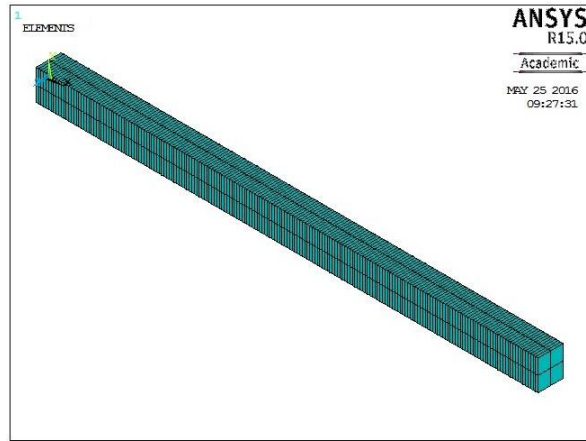

Load Vector

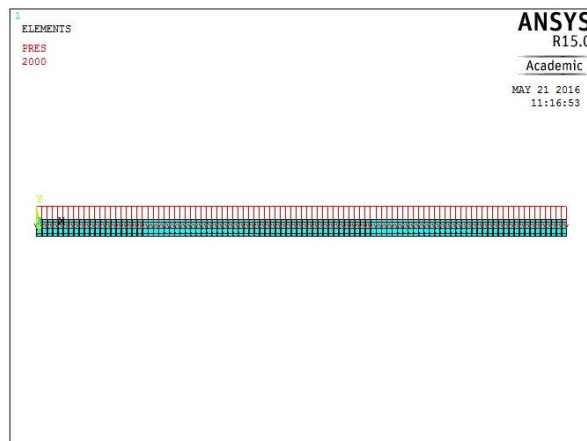

Ex.No	11	HARMONIC ANALYSIS ON CANTILEVER BEAM WITH UDL
Date		

Aim:-

To perform harmonic analysis on a Cantilever Beam with UDL by using ANSYS 15.0 analysis software.

System

Configuration:-

Requirements

System : Windows 10 (64 Bit)

Processor : Intel Core i3

Speed : 3.60 GHz

Ram : 4 GB

HDD : 1 TB

Software

ANSYS 15.0 software

Procedure:-

It involves three basic types of operations

1. Pre Processing
2. Solution
3. Post Processing

Preprocessing:-

1. Structural / h – method/structural
2. Preprocessor/Element type/Add/edit/delete/Add/ Beam/ 2 nodes 188/ok/close
3. Material props/material models/structural/linear/elastic/isotropic/Exx = 2e5/PRxy=0.3/ok/close
4. Sections / Beam/Common section/Sub type -I section/Enter the dimension B= 50, H= 60/ok
5. Modeling/Create/key points/ Inactive CS/x=0 y=0 z =0/Apply/x=1000 y=0 z=0/Apply x=0 y=75 z=0/ok.
6. Modeling/Create/Lines/lines/In Active Coord/Select keypoint1 and track the mouse into select key point 2.
7. Meshing/mesh tool/Element attributes/select line/set/pick orientation key point is yes/ select key point 3/ok.
8. Meshing /mesh tool/size controls/lines/set/select line/Enter the value no of division=100 or element length is 10/ok.
9. Meshing /mesh tool/mesh/select the line/ok.

Solution:-

10. Solution/Analysis Type/ New Analysis/ Harmonic/ ok
11. Solution / Analysis Type / analysis option/ ok/ Sparse solver/ ok
12. Solution/ Load step option/ solution control/ Program chosen /ok.

Frequency Vs Amplitude At x different locations ($x = L$) Linear

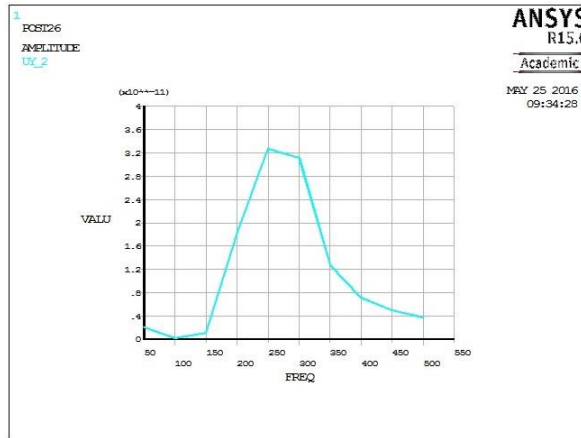

Logarithmic

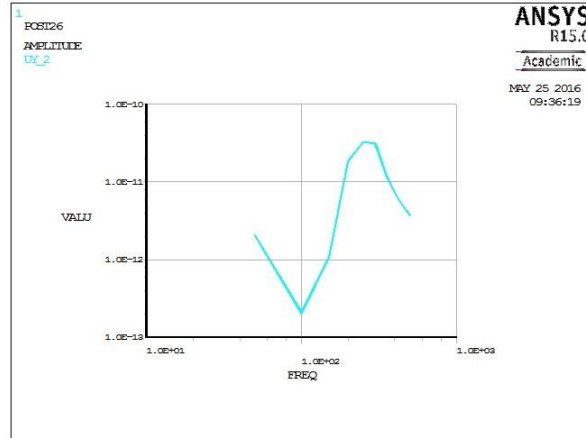

Frequency Vs Amplitude At x different locations ($x = L/2$) Linear

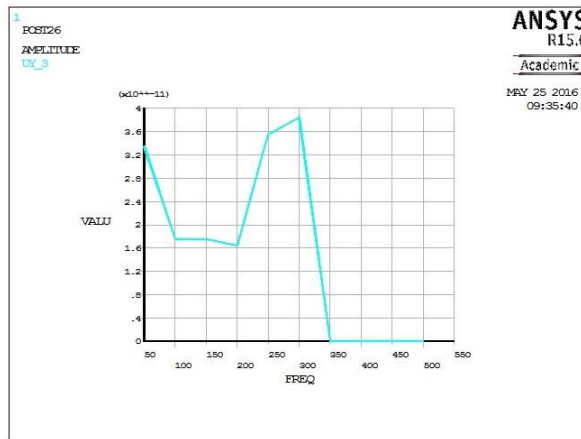

13. Solution/ Load step option/ Time/ frequency sub steps/ 0 to 500/ *enter no of substeps = 10*/ Stepped/ok
14. Solution/Define the Loads /Structural / Displacement/on nodes/ (Pick node 1)all Dof/ok and Pressure
15. Solution/Define the Loads /Structural / Pressure/on beams/ (Pick all) enter the pressure value at I = 200/ok
16. Solution/ solve/ current LS / Solution is done/ close.

Post Processing:-

17. Time hist post processing/Add data/Nodal solution /DOF solution /Y component displacement.
18. Time hist post processing /Graph data/ Capture image
19. The same procedure was followed for different x locations.
20. For better result/Plot cntrls/Style/Graph/modify axes/ Y-axis /Logarithmic

Logarithmic

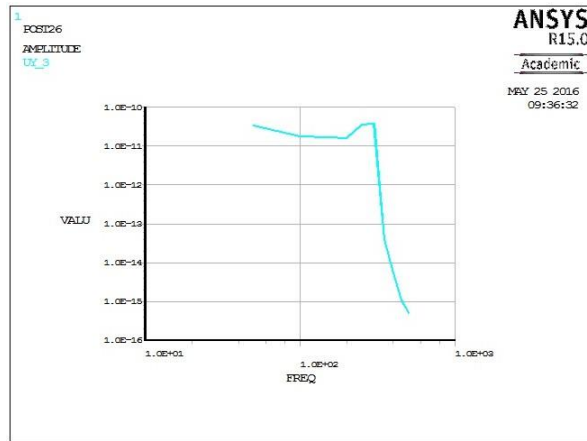

Frequency - Strain

Output:-

S.No	Description	Linear		Logarithmic	
		Maximum Amplitude/stress /strain	Frequency	Maximum Amplitude/stress/ strain	Frequency
1	Amplitude Vs Frequency at $X = L$				
2	Amplitude Vs Frequency at $X = L/2$				
3	Stress Vs Frequency				
4	Strain Vs Frequency				

Result:-

Thus the harmonic analysis on a cantilever beam with UDL was performed by using ANSYS 15.0 analysis software.

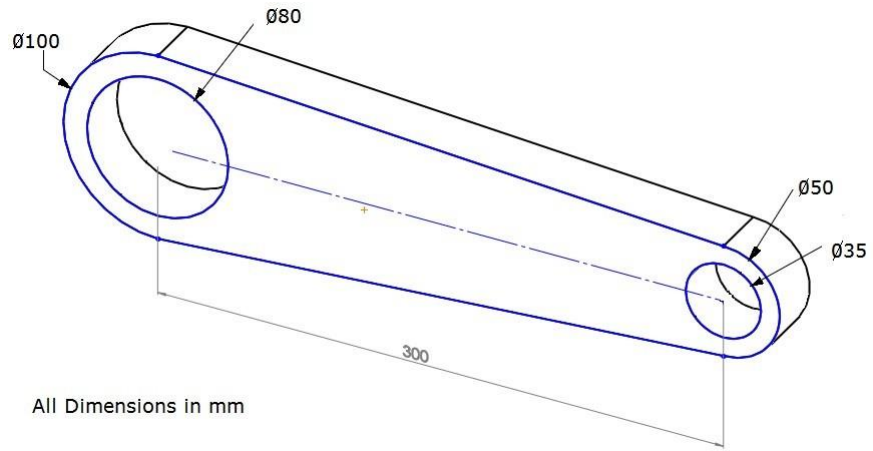

All Dimensions in mm

Meshing of Model

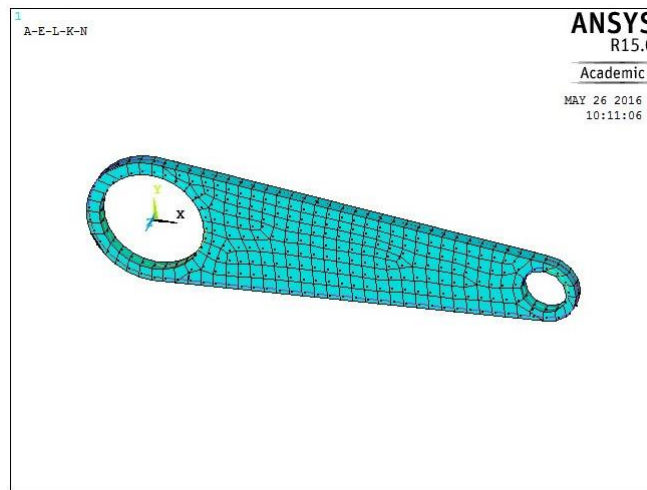

Displacement Solution Time: 5th Sec

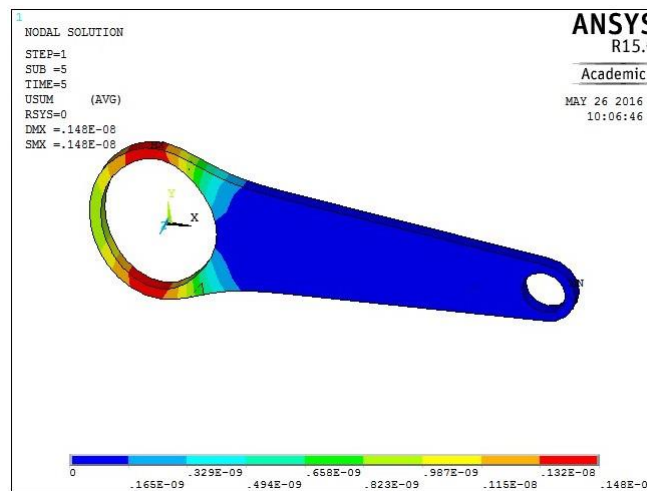

Ex.No	12	TRANSIENT ANALYSIS ON A SIMPLE MECHANICAL ELEMENT
Date		

Aim:-

To perform Conductive heat transfer analysis on a 3D cube by using ANSYS 15.0 analysis software.

System Configuration Requirements

System : Windows 10 (64 Bit)

Processor : Intel Core i3

Speed : 3.60 GHz

Ram : 4 GB

HDD : 1 TB

Software

ANSYS 15.0 software

Procedure:-

It involves three basic types of operations

1. Pre Processing
2. Solution
3. Post Processing

Preprocessing:-

1. Thermal / h – method/structural
2. Element type /Add/edits / delete / add/solid / Quad 4 node 182/ok/options/plane stress with thk /ok /close
3. Real constants/Add//edit/delete/Add/ok/Enter cross thickness = 0.01
4. Material prop/import lib/Browse/C drive/Program files/Ansys inc /v150/ ansys / mat lib /stl_AISI-304/ok/close.
5. Modeling/create / Area /circle/ Solid circle / x=0, y=0, Radius = 0.05/Apply/ x = 0.3, y = 0 & R = 0.025/ ok.
6. Modeling/create / Area /arbitrary/ throu key points/ select big circle top point firstthen select small circle top point/ then small circle bottom point and finally big circlebottom point/ ok.
7. Modeling/ Operate/ Booleans/ add/ select area1/apply/area3/apply/ select area2/ apply /select area3/ ok.
8. Modeling/create / Area /circle/ Solid circle / x=0, y=0, Radius = 0.04/Apply/ x = 0.3, y = 0 & R = 0.0175 / ok.
9. Meshing/ mesh tool / mesh attributes/ area/set/select area/ok.
10. Meshing/ mesh tool / size controls/ area/set/select area/ element length = 0.01 /ok.
11. Meshing/ mesh tool /area / mesh/select area/ok.

Time: 10th Sec

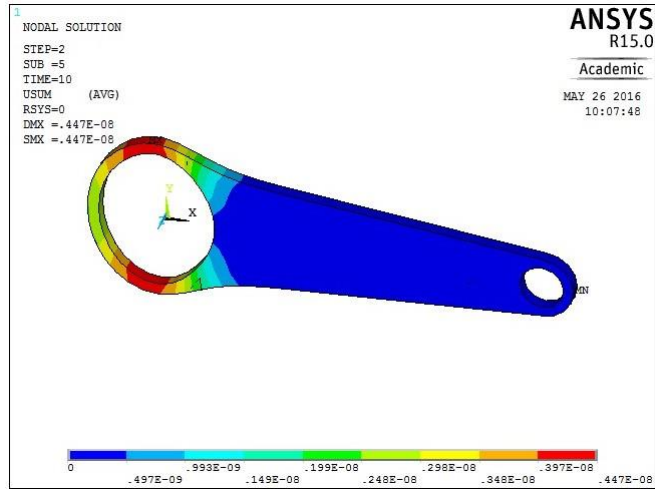

Time: 15th Sec

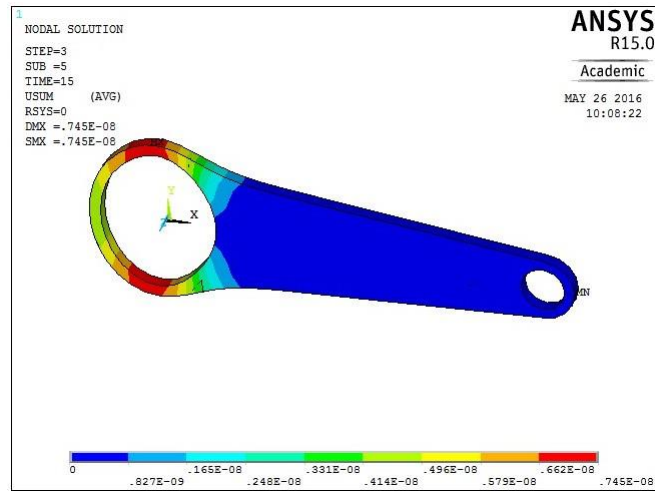

Stress Solution
Time: 5th Sec

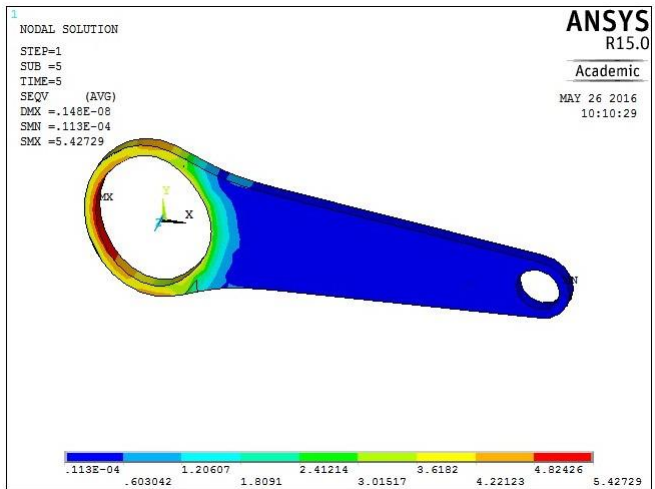

Solution:-

12. Analysis type/ new analysis/ Transient/ok
13. Analysis type/ soln control/ Time at end of load step = 5/ No of sub steps = 5/ Max no of sub steps = 5/ Min no of sub steps = 1/ok
14. Define the Loads /Apply / structural/ displacement/ on line/*select small hole's inner lines/ all dof/ ok.*
15. Define the Loads /Apply / structural/ Pressure/ on line/ *select Big hole's inner lines/ Pressure value = 5/ ok.*
16. Load step option/ write LS file/ file no: 1/ ok.
17. Analysis type/ soln control/ Time at end of load step = 10/ No of sub steps = 5/ Max no of sub steps = 5/ Min no of sub steps = 1/ok
18. Define the Loads /Delete / structural/ displacement/ on line/*select Big hole's inner lines/ ok.*
19. Define the Loads /Apply / structural/ Pressure/ on line/ *select Big hole's inner lines/ Pressure value = 10/ ok.*
20. Load step option/ write LS file/ file no: 2/ ok.
17. Analysis type/ soln control/ Time at end of load step = 15/ No of sub steps = 5/ Max no of sub steps = 5/ Min no of sub steps = 1/ok
18. Define the Loads /Delete / structural/ displacement/ on line/*select Big hole's inner lines/ ok.*
19. Define the Loads /Apply / structural/ Pressure/ on line/ *select Big hole's inner lines/ Pressure value = 12/ ok.*
20. Load step option/ write LS file/ file no: 3/ ok.
21. Solve/ From LS files/ starting file number = 1/ ending file no = 3/ file increment = 1/ok/ solution is done.

Post Processing:-

21. Read results / by pick / *select first load step/read/ close.*
22. Plot results /Nodal solution /DOF solution/ Displacement vector sum/ ok. (Capture Image)
23. Plot results /Nodal solution /stress/ von mises stress/ ok. (Capture Image)
24. Plot results /Nodal solution / Total mechanical strain/ von mises strain/ ok. (Capture Image)
25. Read results / by pick / *select second load step/read/ close.*
26. Plot results /Nodal solution /DOF solution/ Displacement vector sum/ ok. (Capture Image)
27. Plot results /Nodal solution /stress/ von mises stress/ ok. (Capture Image)
28. Plot results /Nodal solution / Total mechanical strain/ von mises strain/ ok. (Capture Image)

Time: 10th Sec

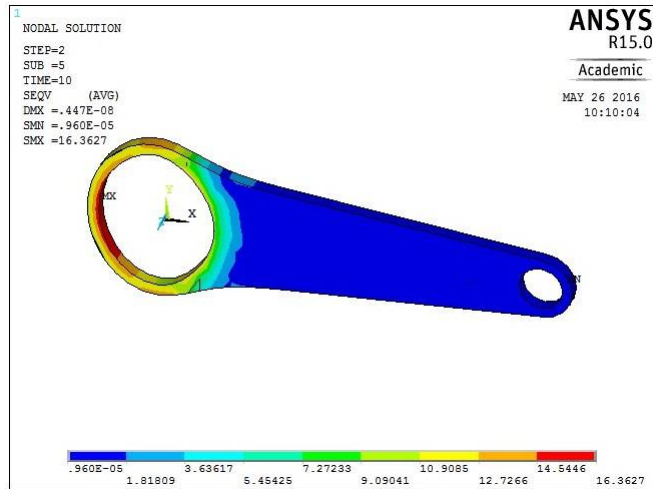

Time: 15th Sec

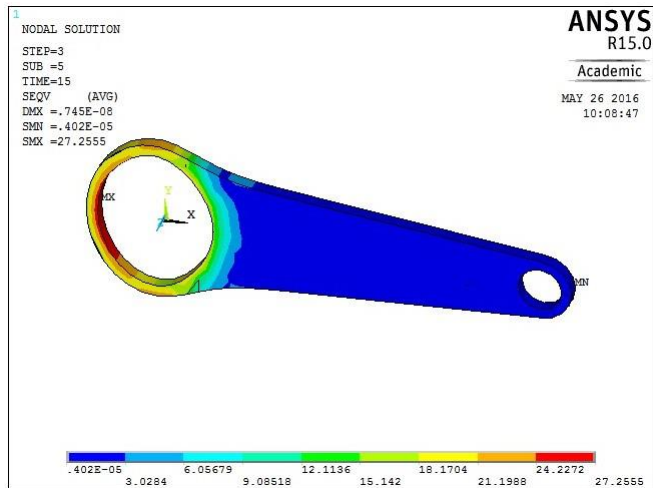

Strain Solution Time: 5th Sec

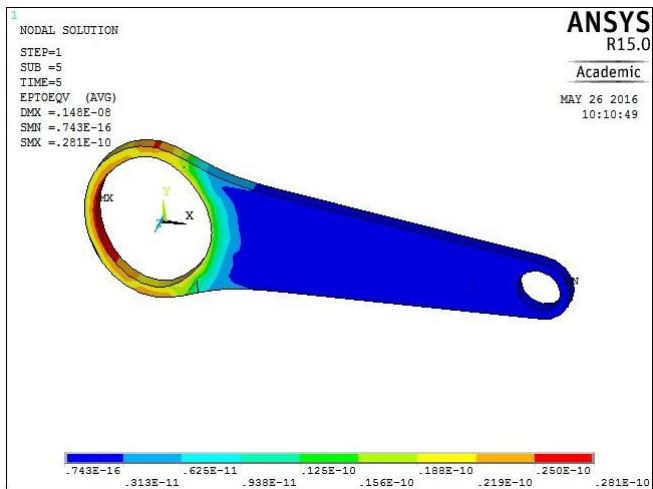

29. Read results / by pick / *select third load step/read/ close.*
30. Plot results /Nodal solution /DOF solution/ Displacement vector sum/ ok. (Capture Image)
31. Plot results /Nodal solution /stress/ von mises stress/ ok. (Capture Image)
32. Plot results /Nodal solution / Total mechanical strain/ von mises strain/ ok. (Capture Image)

Time: 10th Sec

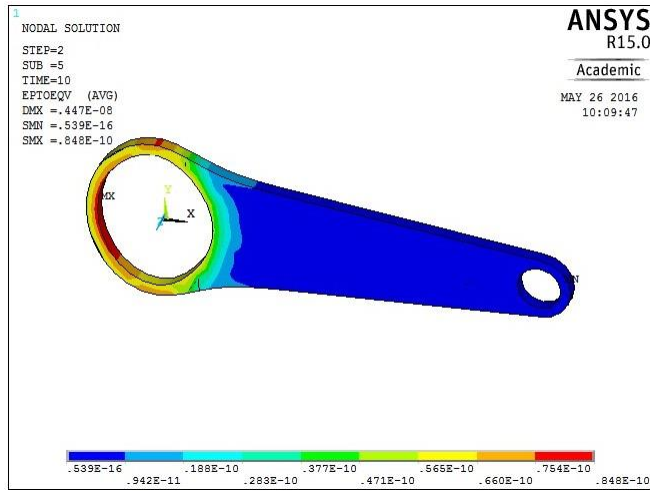

Time: 15th Sec

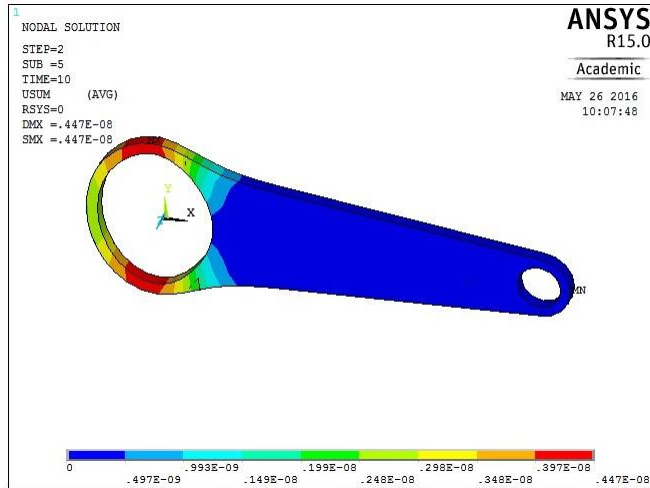

Nodal Results:-

S.no	Description	Load step 1		Load step 2		Load step 3	
		Max	Min	Max	Min	Max	Min
1	Displacement						
2	Stress						
3	Strain						

Result: -

Thus the transient analysis on a simple mechanical element was performed using ANSYS 15.0 analysis software.

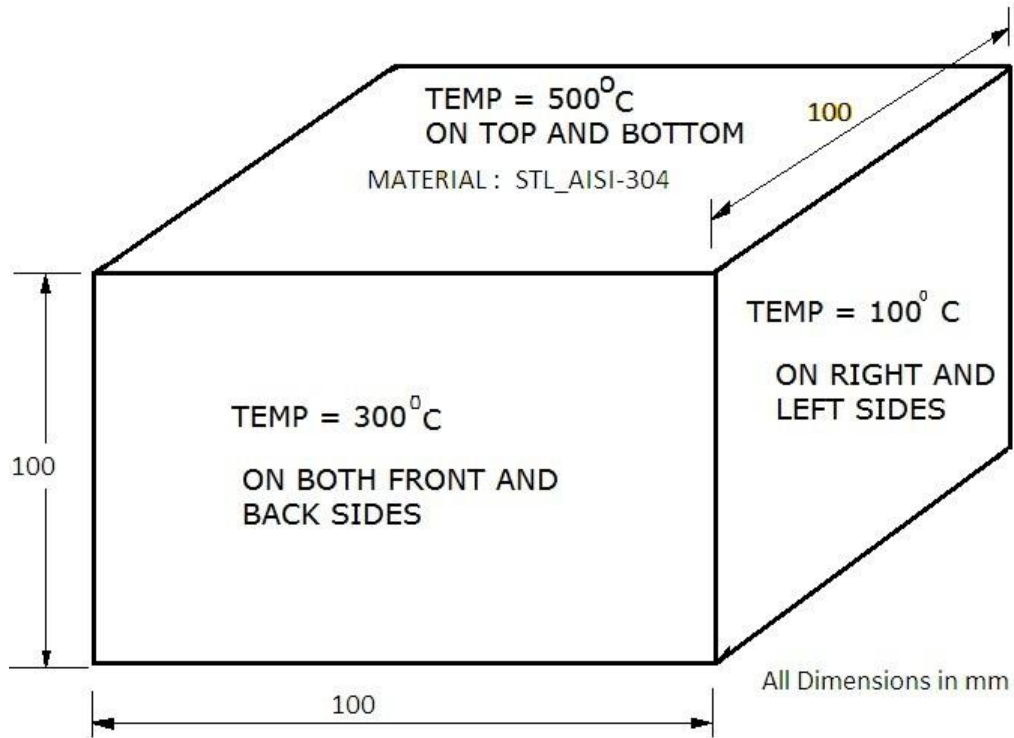

MESHING OF MODEL

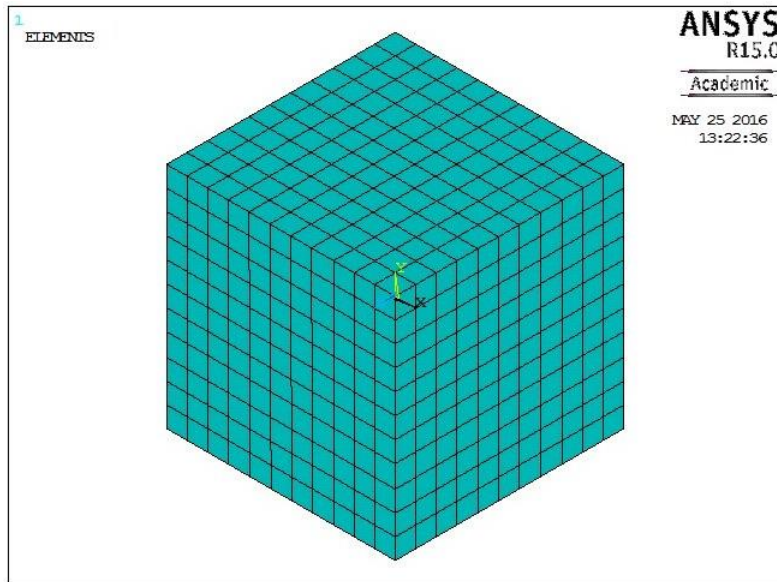

Ex.No	13	CONDUCTIVE HEAT TRANSFER ANALYSIS ON A 3D CUBE
Date		

Aim:-

To perform Conductive heat transfer analysis on a 3D cube by using ANSYS 15.0 analysis software.

System Configuration Requirements

System : Windows 10 (64 Bit)

Processor : Intel Core i3

Speed : 3.60 GHz

Ram : 4 GB

HDD : 1 TB

Software

ANSYS 15.0 software

Procedure:-

It involves three basic types of operations

4. Pre Processing
5. Solution
6. Post Processing

Preprocessing:-

1. Thermal / h – method/thermal

Element type /Add/edit / delete / add/solid / Brick 8 node 278/ok

2. Material prop/import lib/Browse/C drive/Program files/Ansys inc/v150/ ansys / mat lib /stl_AISI-304/ok/close.

3. Modeling/create / volume/block/by 2 corners &Z/ x=0, y=0, Length = 100, Width = 100 and Height = 100/ ok

4. Meshing/ mesh tool / smart size = 2 / sweep & hex /pick all/ok.

Solution:-

5. Define the Loads /Apply /Thermal / Temperature / on areas /select areas and enter temp value as per the diagram

6. Solve/ current LS / solution is done.

Post Processing:-

8. Plot results /Nodal solution /DOF solution/Nodal temp/ok/ Plot controls/ Capture image.

9. Plot results / Nodal solution / Thermal gradient solution/ Plot controls/ Capture image

10. Plot results / Nodal solution / Thermal flux solution/ Plot controls/ Capture image

11. Plot results/ element solu/ heat flow/ok/ Plot controls/ Capture image.

Boundary condition

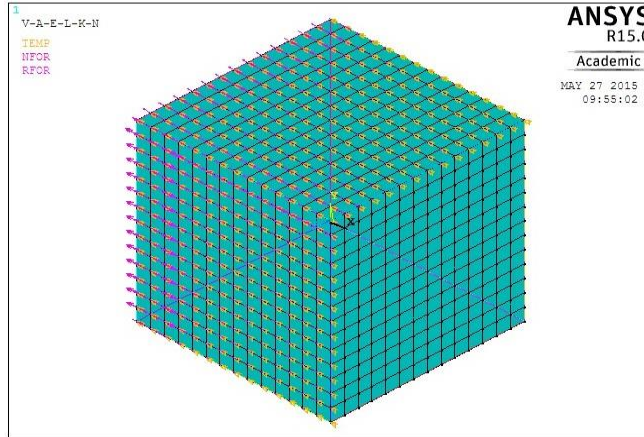

Nodal Temperature

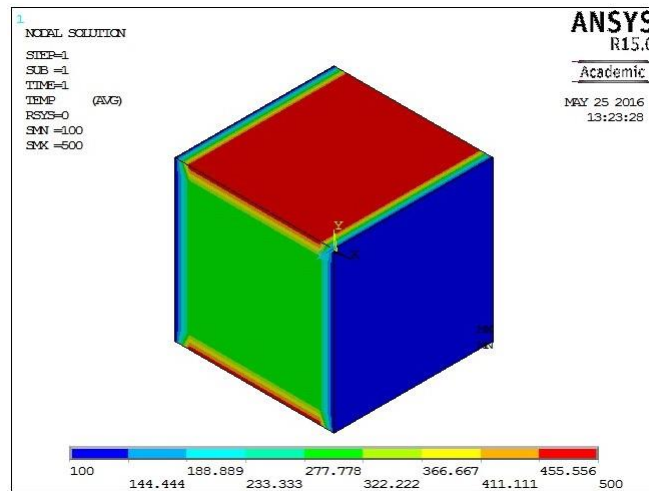

Thermal gradient

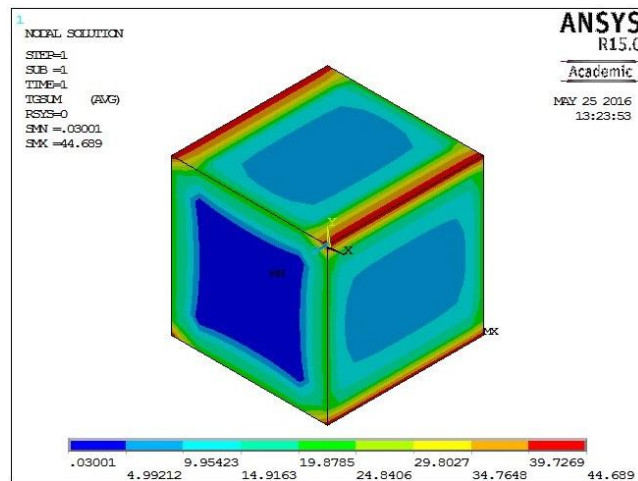

Thermal flux

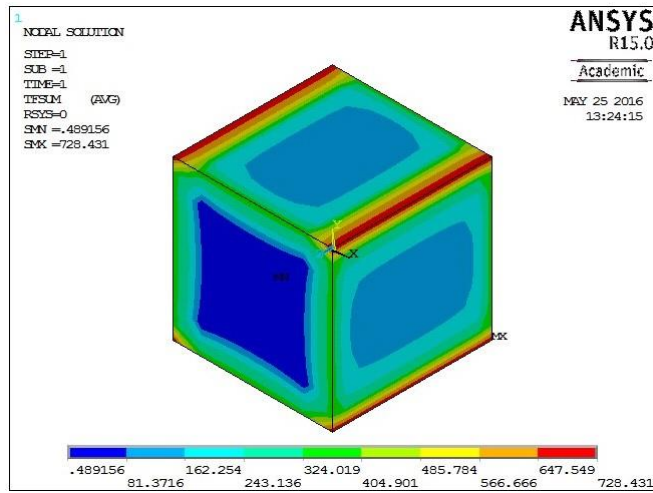

Heat flow

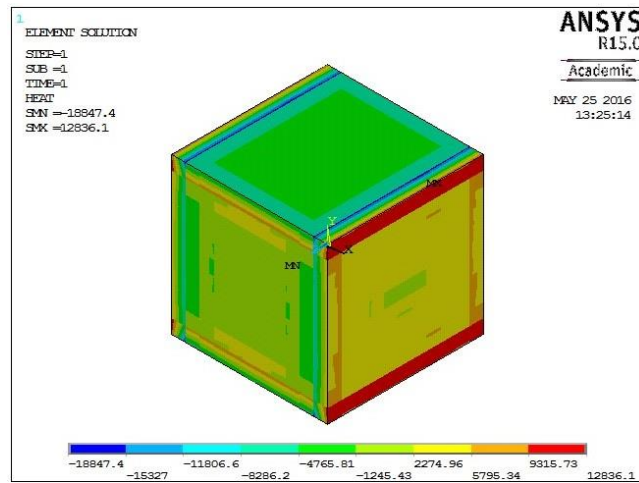

Nodal solution:-

S.No	Parameters	Maximum	Minimum
1	Nodal Temperature		
2	Thermal gradient $w/m^2 \text{ } ^\circ C$		
3	Thermal flux $w/m^3 \text{ } ^\circ C$		
4	Heat flow in $Kg/^\circ C$		

Result:-

Thus the conductive heat transfer analysis was performed by using ANSYS 15.0 analysis software.

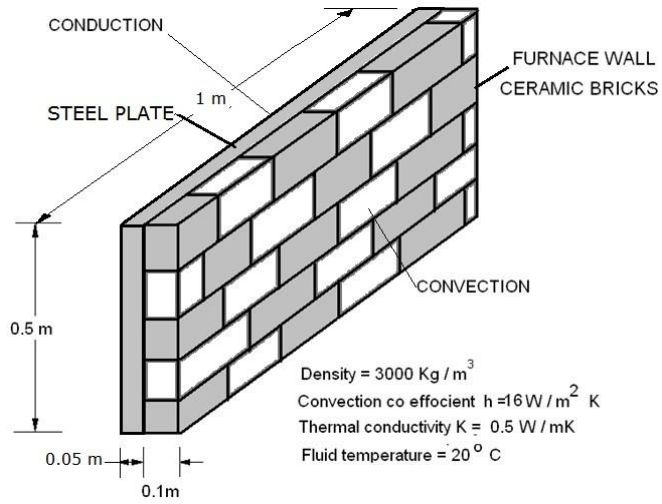

Meshing of Model / Boundary condition

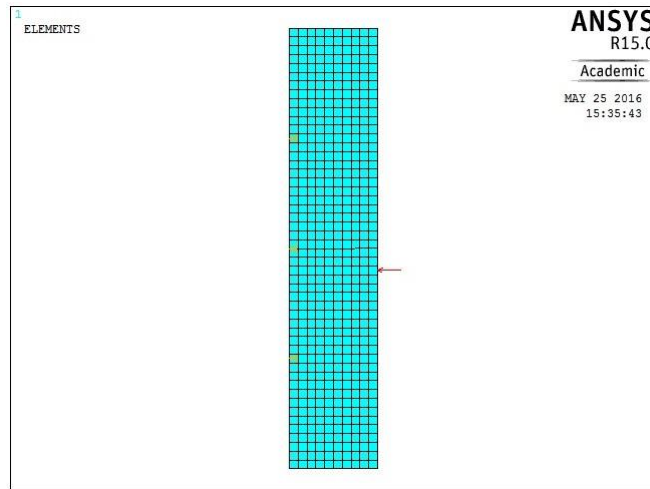

Nodal Solution Temperature Distribution

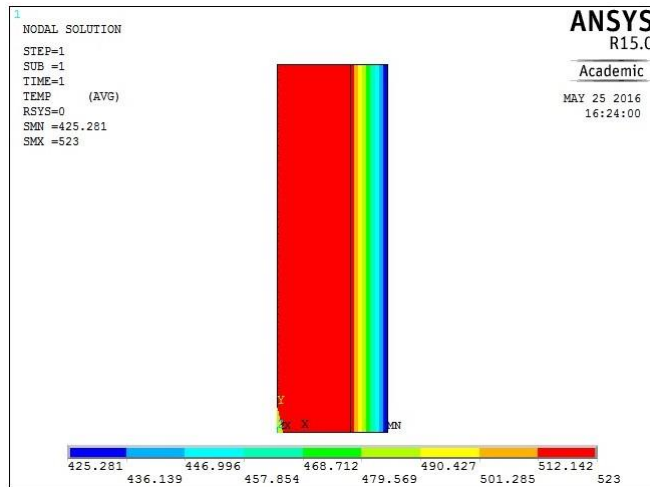

Ex.No	15	CONDUCTIVE AND CONVECTIVE HEAT TRANSFER ANALYSIS ON A FURNACE WALL
Date		

Aim:-

To perform conductive and convective heat transfer analysis in furnace wall by using ANSYS 15.0 analysis software.

System

Configuration:-

Requirements

System : Windows 10 (64 Bit)
 Processor : Intel Core i3
 Speed : 3.60 GHz
 Ram : 4 GB
 HDD : 1 TB

Software

ANSYS 15.0 software

Procedure:-

It involves three basic types of operations

1. Pre Processing
2. Solution
3. Post Processing

Preprocessing:-

1. Thermal / h – method/thermal
2. Element type /Add/edits / delete / add/solid / Quad 4 node 182/ok/options/plane stress with thk /ok /close
3. Real constants/Add//edit/delete/Add/ok/Enter cross thickness = 1
4. Material prop/ material model/ thermal/ conductivity / isotropic/ linear/kxx = 50/ density = 7.8e4
5. Material prop//material model/ new model/ thermal/ conductivity / isotropic/ linear/kxx = 1/ density = 2e4/close
6. Modeling/create / Area /circle/ Solid circle / x=0, y=0, width = 0.05 height = 0.75 /Apply/ x = 0.05, y = 0 width = 0.1 height = 0.75 / ok.
7. Modeling/operate/ Booleans/ glue/ select area1/apply/ select area 2/ok
8. Meshing / mesh tool/ mesh attributes/ material no 1/ select area1/apply/material no 2/ select area 2/ok.
9. Meshing / mesh tool/ size control/ area / set/ select area/ element edge length = 0.01/apply/ select area 2 / element edge length = 0.01/ok.
10. Meshing / mesh tool/area/ mesh / select area 1/apply/ select area 2 /ok.

Solution

11. Define loads/ apply / thermal/ conduction / on lines/ select left side line/ enter the temp value = 500

12. Define loads/ apply / thermal/ convection/ enter heat transfer film co efficient = 15

Temperature Distribution

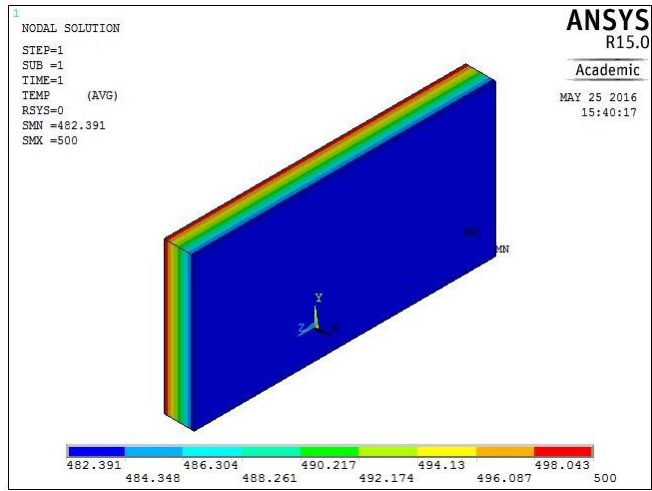

Bulk temperature = 300/ok

13. Solve/ current LS/solution is done/close.

Post Process sing:-

14. Plot results /Nodal solution /DOF solution/Nodal temp/ok/ Plot controls/ Capture image.

Temperature at inside the wall = 500 K

Temperature at outside the wall =

Result:-

Thus the conductive and convective heat transfer analysis was performed on a furnace wall by using ANSYS 15.0 analysis software.

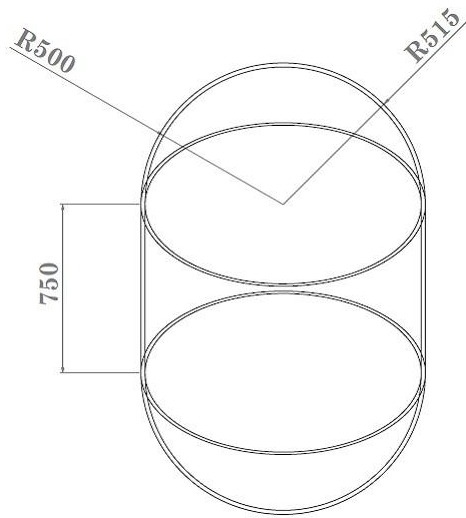

Observation:-

Deformed Results

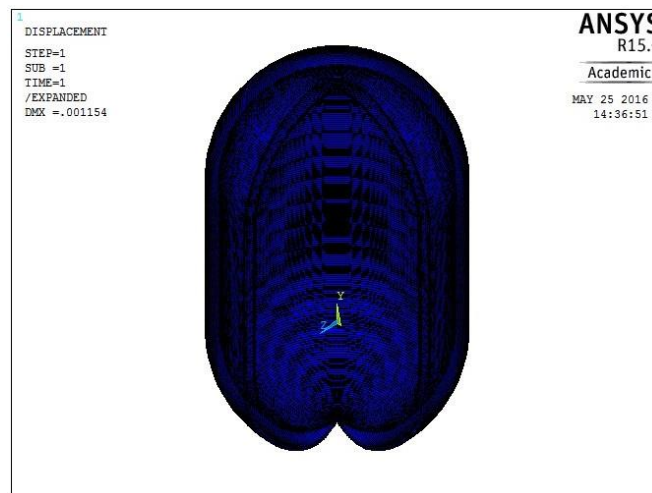
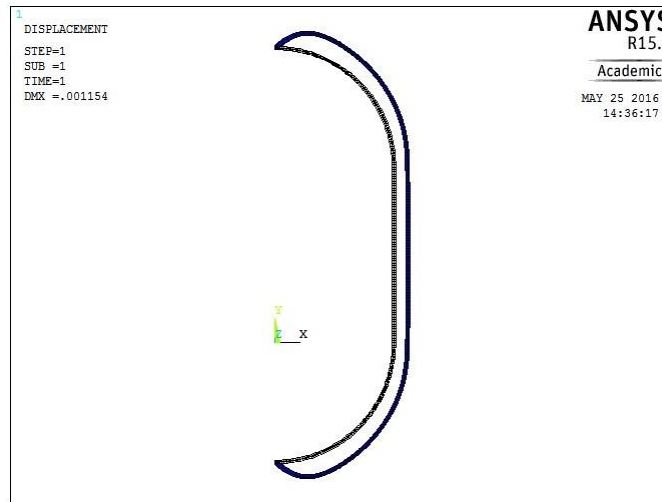

Ex.No	15	THERMAL STRESS ANALYSIS ON BOILER SHELL
Date		

Aim:

To perform static thermal analysis of thin boiler shell (axi-symmetric) by using ANSYS 15.0 analysis software.

System**Configuration:-****Requirements**

System : Windows 10 (64 Bit)

Processor : Intel Core i3

Speed : 3.60 GHz

Ram : 4 GB

HDD : 1 TB

Software

ANSYS 15.0 software

Procedure:-

It involves three basic types of operations

1. Pre Processing
2. Solution
3. Post Processing

Preprocessing

1. Structural / h – method/structural
2. Preprocessor/Element type/Add/edit/delete/Add/ solid/ Quad 4 node 182 / ok / options/Axisymmetric/ok/close
3. Material prop/import lib/Browse/C drive/Program files/Ansys inc/v150/ ansys / mat lib /stl_AISI-304/ok/close.
4. Modeling/Create/Area/Rectangle/By 2 corner/X = 0.5, Y=0, Width = 0.015 and Height = 0.75 /ok.
5. Modeling/Create/Area/ circle/ By dimensions/outer radius = 0.515 / inner radius = 0.5 /starting angle = 270 /Ending angle = 360/apply/ outer radius = 0.515 / inner radius = 0.5 /starting angle = 0/ Ending angle = 90/ok.
6. Modeling/ move/modify/areas/area/Y offset = 0.75/ok
7. Modeling / operate/ Booleans/ Add/ select area 1 and 2/apply/ select area 1 and 3/ ok.
5. Meshing/mesh tool/size controls/area/ set (click)/select area/enter element size = 0.001/ok
6. Meshing/mesh tool/ mesh/ select area/ok.

Solution:-

7. Solution/Define Loads /Apply/Structural / Displacement /on lines/select top and

bottom lines/All dof/ok

Temperature Distribution

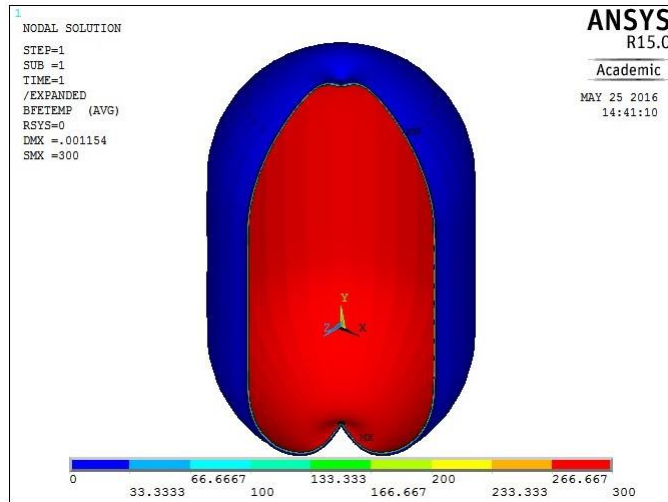

Displacement Results X- Displacement

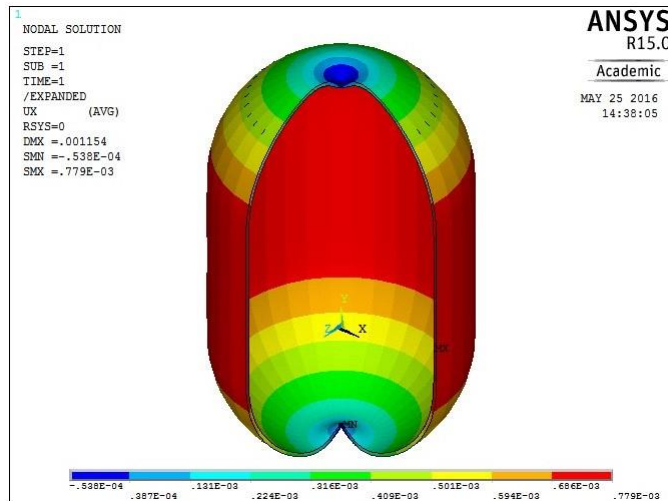

Y- Displacement

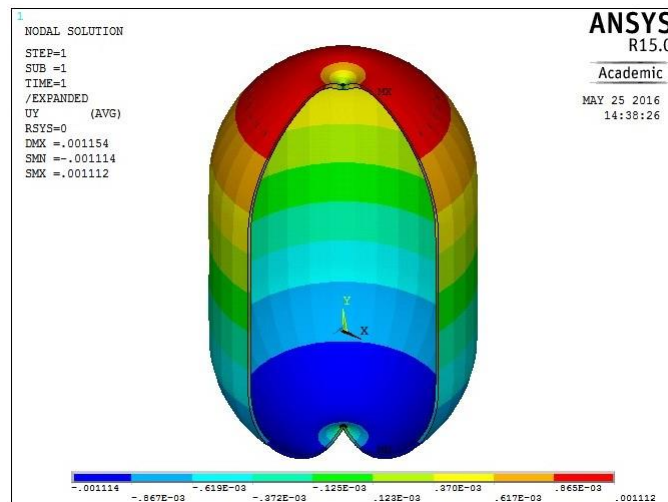

8. Solution/Define Loads /Apply/Structural /pressure/on lines/ select vertical inside line/ok/enter the pressure value = 5 e5/ok

9. Solution/Solve/Current LS/ok/Solution is done.

Post Processing:-

10. Plot results for deformed/ Def + unreformed shape/*plot controls/capture image.*

10. Plot results for deformed/ Def + unreformed shape/*plot controls/Style/size and shape/Display object /on/ok*

11. *Plot controls/Style/size and shape/Symmetric expansion/2D axi-symmetric/select the options/ok/plot controls/capture image.*

12. Plot results for Contour plot/Nodal solu/Nodal solution/DOF solution/ X component of displacement. */plot controls/capture image.*

13. Plot results for Contour plot/Nodal solu/Nodal solution/DOF solution/ Y component of displacement. */plot controls/capture image.*

14. Plot results for Contour plot/Nodal solution/stress/ Von mises stress */plot controls/capture image.*

15. Plot results for Contour plot/Nodal solution/Total Mechanical strain/von mises strain/*plot controls/capture image.*

Thermal stress

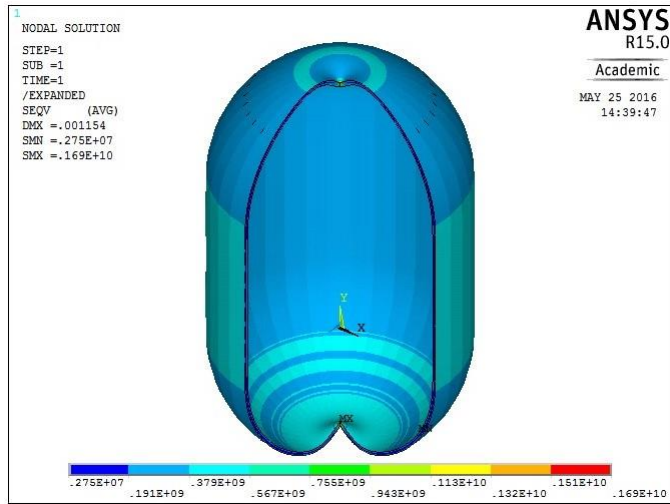

Thermal strain

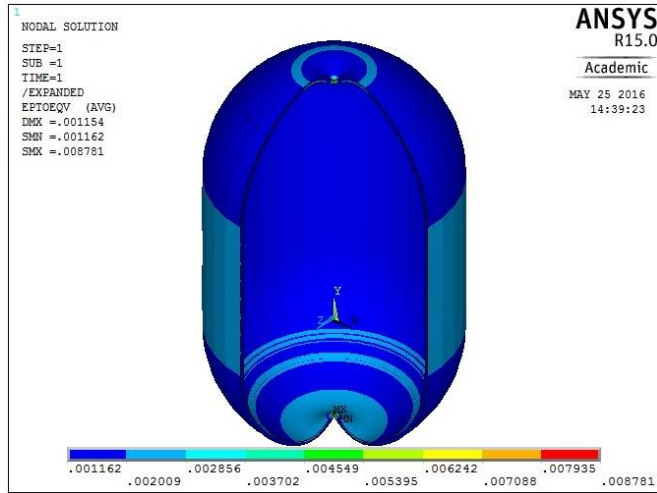

Nodal solution:-

S.No	Parameters	Maximum	Minimum
1	X- Displacement in m		
2	Y – Displacement in m		
3	Thermal stress in N / mm ²		
4	Thermal strain		
5	Nodal Temperature in K		

Result:-

Thus the thermal analysis of given 2D plate element was performed by using ANSYS 15.0 analysis software.

ANNA UNIVERSITY: CHENNAI- 600 025
B.E./B.Tech. DEGREE EXAMINATIONS, Nov./Dec.- 2014
Regulations-2008
Seventh Semester
B.E. MECHANICAL ENGINEERING

ME2404: COMPUTER AIDED SIMULATION AND ANALYSIS LABORATORY

Time: 3 Hours

Maximum Marks: 100

1. Highlight the stress distribution on plate with circular hole as shown in Figure 1 and obtain the plot for deformed shape and stress distribution for given load and assume suitable boundary condition. Young's modulus= $2 \times 10^5 \text{ N/mm}^2$; Poisson's ratio=0.3; Pressure Applied around the inside of the hole= 25000 N ; Material properties: Linear, Elastic, and Isotropic.

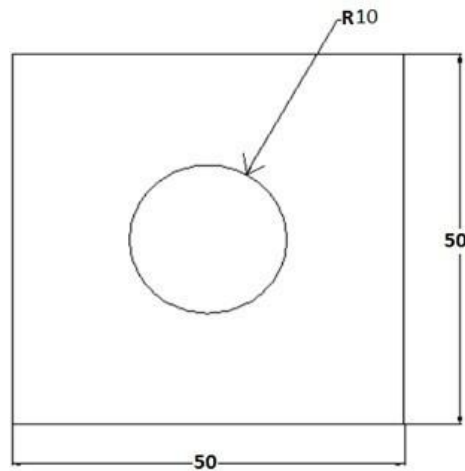

Figure 1

All dimensions are in 'mm'.

(100)

2. Analyze the given L-Bracket for stress as shown in Figure 2 and obtain plot for stress distribution and deformed shape by applying suitable boundary condition. $E=2 \times 10^5 \text{ N/mm}^2$, Poisson's ratio =0.3 Yield stress including safety factor 400 MPa. Options: Plane Stress; Real Constant: No need to define; Material Properties: Linear, Isotropic.

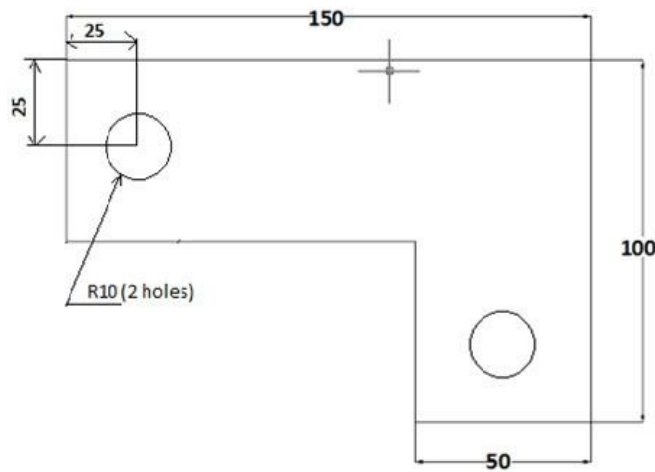

Figure 2

All dimensions are in 'mm'.

(100)

3. Obtain the stress distribution of an axi symmetric component shown in Figure 3. The model will be that of a closed tube made from steel. Point load of 50 KN will be applied at the centre of the top and bottom plate.

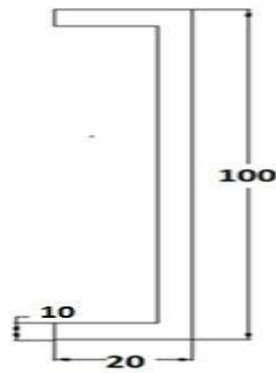

Figure 3

All dimensions are in 'mm'

(100)

4. (a). A distributed load & Point load will be applied to a solid steel beam with a rectangular cross section as shown in the Figure 4(a) below. The cross-section of the beam is 132 mm x 264 mm while the modulus of elasticity of the steel is 210GPa. Find reaction, deflection and stresses in the beam.

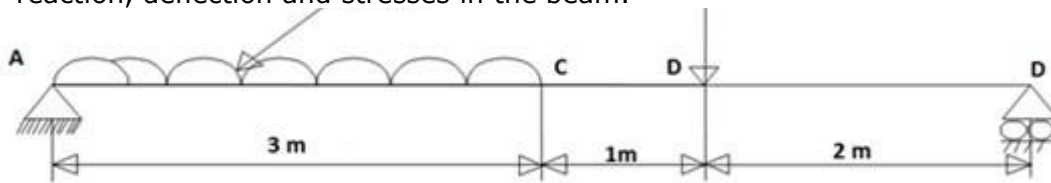

Figure 4 (a)

(50)

4. (b). Find the various modes of frequencies for the beam shown in Figure 4 (b). Modulus of Elasticity $E=206800 \times 10^6 \text{ N/m}^2$; Density $=7830 \text{ kg/m}^3$. All dimensions are in mm.



Figure 4 (b)

(50)

1. (a). A distributed load & Point load will be applied to a solid steel beam with a rectangular cross section as shown in the Figure 5(a). The cross-section of the beam is 150mm x 300mm while the modulus of elasticity of the steel is 210GPa. Find reaction, deflection and stresses in the beam.



Figure 4 (b)

(50)

5. (b) Find the various modes of frequencies for the beam shown in Figure 5(b). Modulus of Elasticity $E=206800 \times 10^6 \text{ N/m}^2$; Density $=7830 \text{ kg/m}^3$. All dimensions in mm.



6. (a) A distributed load & Point load will be applied to a solid steel beam with a rectangular cross section as shown in the Figure 6(a). The cross-section of the beam is 572 mm x 1144 mm while the modulus of elasticity of the steel is 210GPa. Find reaction, deflection and stresses in the beam.

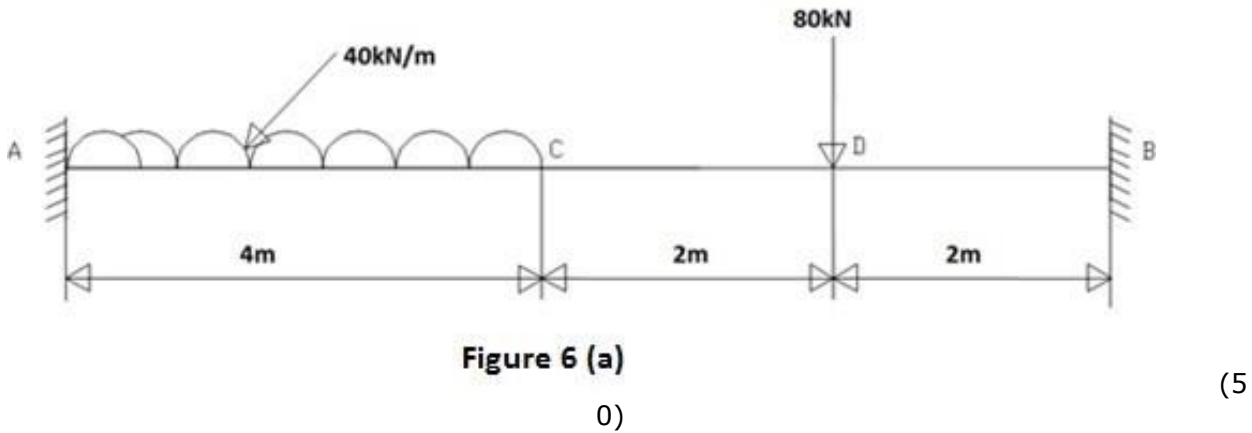

6. (b) Find the various modes of frequencies for the beam shown in Figure 6(b). Modulus of Elasticity $E=206800 \times 10^6 \text{ N/m}^2$; Density $=7830 \text{ kg/m}^3$



7. Find the various modes of frequencies for the given 2D component shown in Figure 7. All dimensions are in mm.



Figure 7 (100)

8. Find the various modes of frequencies for the given 2D component in Figure 8. All dimensions are in mm.

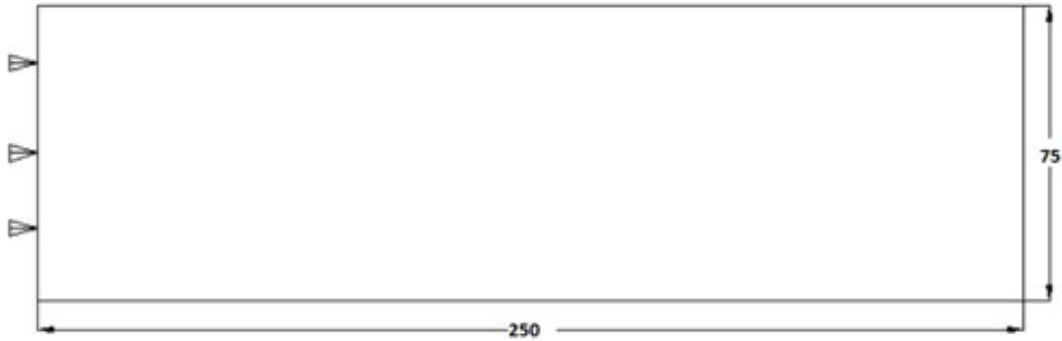

Figure 8

(100)

9. (a) Find the various modes of frequencies for the beam shown in Figure 9(a). Modulus of Elasticity $E=206800 \times 10^6 \text{ N/m}^2$; Density $=7830 \text{ kg/m}^3$



Figure 9 (a)

(50)

9. (b) A distributed load & Point load will be applied to a solid steel beam with a rectangular cross section as shown in the Figure 9(b) below. The cross-section of the beam is 572 mm x 1144 mm while the modulus of elasticity of the steel is 210GPa. Find reaction, deflection and stresses in the beam.

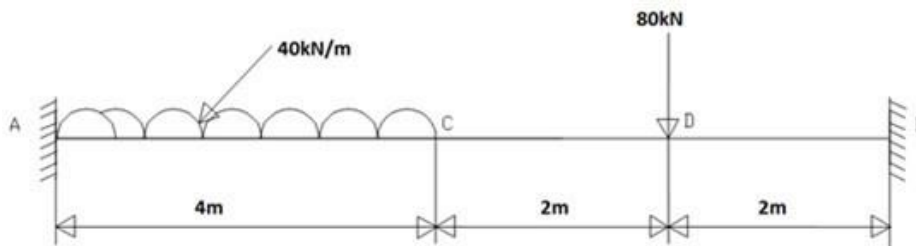

Figure 9 (b)

(50)

10. (a) Find the various modes of frequencies for the beam shown in Figure 10(a). Modulus of Elasticity $E=206800 \times 10^6 \text{ N/m}^2$; Density $=7830 \text{ kg/m}^3$



Figure 10 (a)

(50)

10. (b) A distributed load & Point load will be applied to a solid steel beam with a rectangular cross section as shown in the Figure 10(b). The cross-section of the beam

is 150mm x 300mm while the modulus of elasticity of the steel is 210GPa. Find reaction, deflection and stresses in the beam.

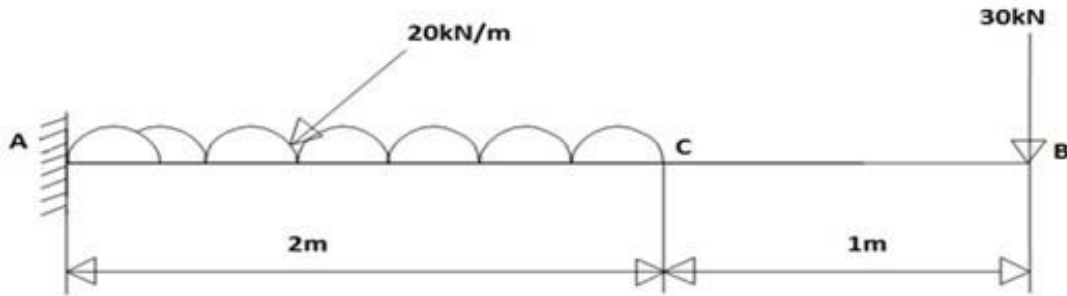

Figure 10 (b)

(50)

11. (a) Find the various modes of frequencies for the beam shown in Figure 11(a). Modulus of Elasticity $E=206800 \times 10^6 \text{ N/m}^2$; Density $=7830 \text{ kg/m}^3$



Figure 11 (a)

(50)

(b) A distributed load & Point load will be applied to a solid steel beam with a rectangular cross section as shown in the Figure 11(b). The cross-section of the beam is 132 mm x 264 mm while the modulus of elasticity of the steel is 210GPa. Find reaction, deflection and stresses in the beam.

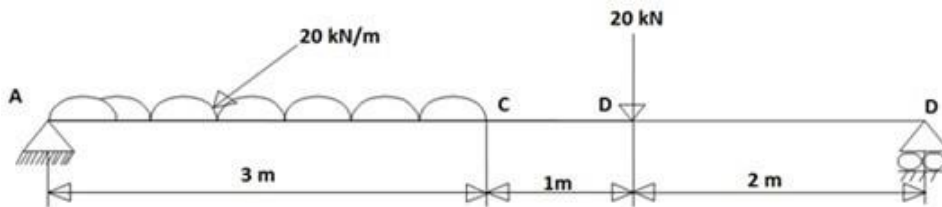

Figure 11 (b)

(50)

12. Conduct a harmonic force response analysis on the cantilever beam shown in Figure 12 by applying a cyclic load (harmonic) at the end of the beam. The frequency of load may be varied from 1-100 Hz. Modulus of Elasticity $E=206800 \times 10^6 \text{ N/m}^2$; Density $=7830 \text{ kg/m}^3$

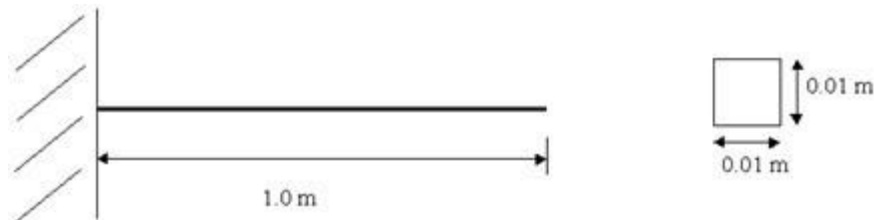

Figure 12

(100)

13. Perform a conduction analysis for temperature distribution on the block which is constrained as shown in the Figure 13. Thermal conductivity (k) of the material is $10 \text{ W/m}^\circ\text{C}$ and the block is assumed to be infinitely long.

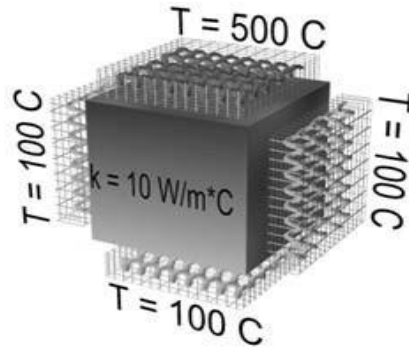

Figure 13

(100)

14. A steel cooling spine of cross-sectional area A and length L extend from a wall maintained at temperature T_w (Figure 14). The surface convection coefficient between the spine and the surrounding air is h , the air temperature is T_a , and the tip of the spine is insulated. Apply advanced mesh control with element size of $0.025'$. Find the heat conducted by the spine and the temperature of the tip. **Material properties**

$E = 2.1 \times 10^5 \text{ N/mm}^2$; $\nu = 0.33$; $k = 20 \text{ W/m K}$;

Geometric properties

$A = 20 \times 20 \text{ mm}^2$; $L = 120 \text{ mm}$

Boundary conditions

$T_w = 100^\circ\text{T}$; $T_a = 30^\circ\text{T}$; $h = 50 \text{ W}/(\text{m}^2\text{K})$

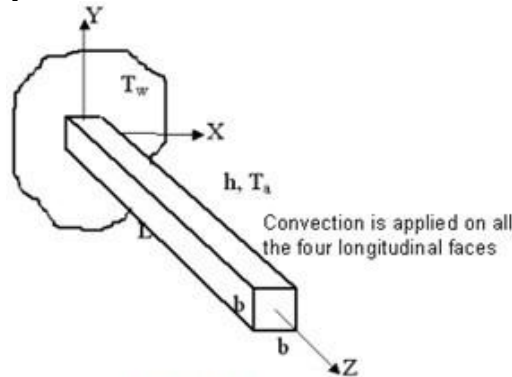

Figure 14

(100)

15. Analyze the given rectangular plate shown in Figure 15 for temperature distribution. Thermal conductivity of the plate, $K_{XX} = 401 \text{ W}/(\text{m}\cdot\text{K})$

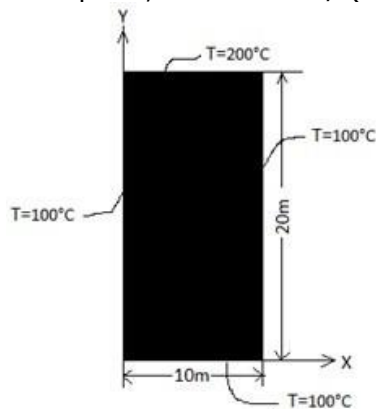

Figure 15

(100)

16. Perform a simulation of an air conditioning system with condenser and evaporator temperatures as input to get COP using C/MAT Lab. Assume suitable variables.
(100)

17. Perform a simulation for the working of a double acting cylinder for any one application using C/MAT Lab.
(100)

18. Explain the step by step procedure for performing the simulation of cam and follower mechanism as shown in figure. Also perform the simulation using C/MAT Lab.



Figure 18

(100)

19. Analyse the given bracket (Figure 19) built from a 20 mm thick steel plate for deflection and Stress by treating it as plane stress condition. The material is steel. Take $E=200$ GPa and $\mu=0.25$

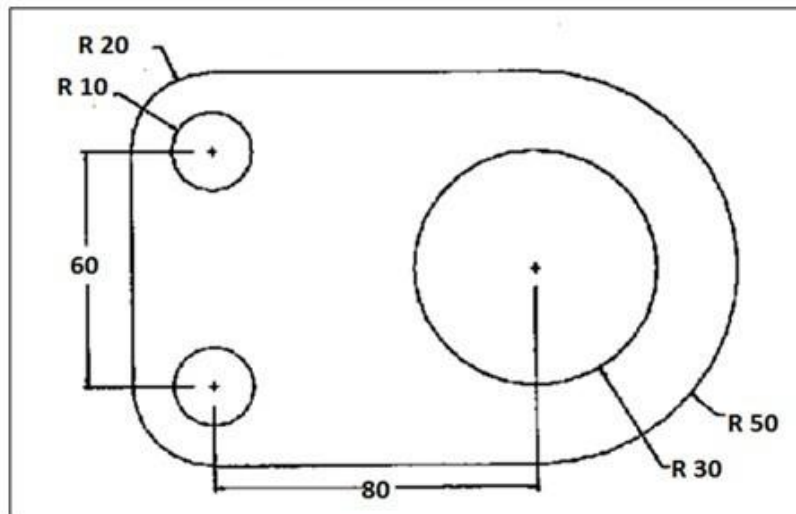

Figure 19

(100)

20. (a) Analyse the deflection and stresses in the beam shown in Figure 20(a). The cross section of the beam is 500 mm × 1500 mm. Take $E=210$ GPa.

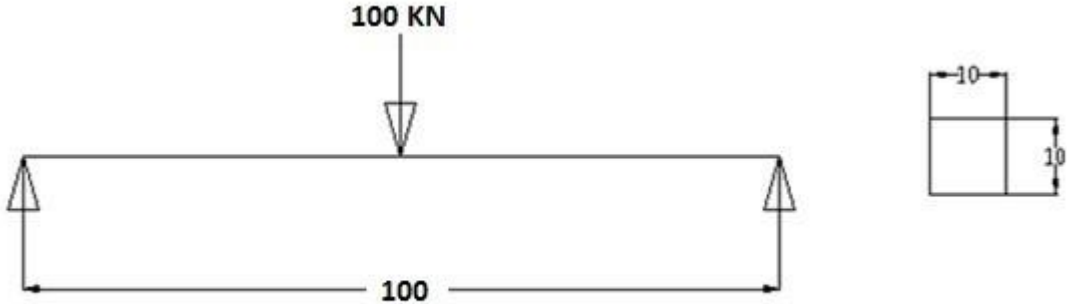

Figure 20 (a)

(50)

20. (b) Analyse the deflection and stresses in the simply supported beam shown in Figure 20(b). The cross section of the beam is 500 mm × 1500 mm. Take $E=210$ GPa.

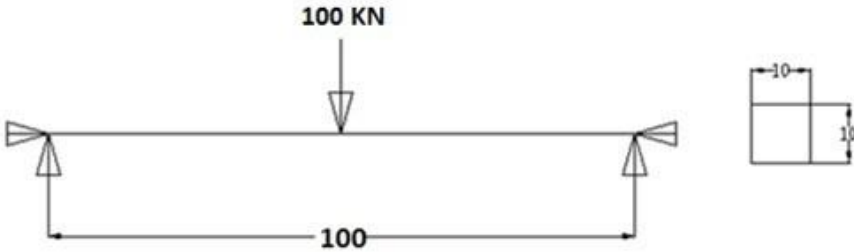

Figure 20 (b)

(50)

VIVA - VOCE QUESTIONS:-

1. How to discrete the element in Ansys?
2. What is translation motion?
3. Define mesh attributes.
4. What are degrees of freedom?
5. What are the six degrees of freedom?
6. What is boundary condition?
7. Classify boundary condition.
8. State the governing equation for one dimensional heat conduction problems.
9. What are three process sing in Finite Element Analysis?
10. What are the processes include in pre-process sing?
11. What are the processes include in solution-process sing?
12. What are the processes include in post-process sing?
13. What is meant by nodal displacement?
14. What is mode analysis?
15. What is harmonic analysis?
16. How to give UD load during stress analysis in beams?
17. How to give UV load during stress analysis in beams?
18. How to define simply supported beam while selecting types of beam?
19. How to define the material during structural analysis in Ansys?
20. How to define the material during thermal analysis in Ansys?
21. Define poisson's ratio? Why it is required during analysis?
22. What is elastic constant?
23. State hooks law.
24. What is factor of safety?
25. What are the steps involved in design process?
26. What is simulation?
27. What are the software is available for simulation?
28. What are the software is available for FEA?
29. What are the software is available for Fluid dynamics?
30. What is plane stress analysis?
31. What is plane strain analysis?
32. What is CST element?
33. What is higher order element?
34. What is meant by polynomial function?

ALLOCATION OF MARKS

S.No	Particulars	Maximum Marks	Marks Obtained
1	AIM & PROCEDURE	10	
2	MODELLING AND MESHING	40	
3	SOLUTION	20	
4	RESULTS	20	
5	VIVA- VOCE	10	
6	TOTAL	100	